

ERGOSWISS

table lift systems



NEW PRODUCTS,
ADDITIONAL ARTICLES
AND ACCESSORIES

Novelties	5
Quick Ship Systems	15
Additional article	18
Hand cranks and electronic accessories	24
Mounting accessories	35
Rubber feet and castors	44
Hydraulic accessories	47

MORE PRODUCTS,
MORE INFORMATION,
MORE POSSIBILITIES TO
WORK ERGONOMIC
CAN BE FOUND AT

WWW.ERGOSWISS.COM

AND IN OUR SOCIAL MEDIA.



Errors and technical changes reserved. Ergoswiss AG does not assume any liability for operating errors or using the products outside of the specified normal use. At the time of delivery Ergoswiss AG will replace or repair defect products within accordance with the warranty provisions. In addition, Ergoswiss AG assumes no other liability. For your questions and special custom demand Ergoswiss AG will be at your disposal.

Ergoswiss AG
Nöllenstrasse 15
CH-9443 Widnau
Tel.: +41 (0) 71 727 06 70
info@ergoswiss.com



Novelties

SINGLE COLUMN SNT



Lifting system SNT 1770

- EU** Art. No. 911.51001 [1 Lifting column]
- EU** Art. No. 911.51002 [2 Lifting columns]
- CH** Art. No. 911.51101 [1 Lifting column]
- CH** Art. No. 911.51102 [2 Lifting columns]

T-Slots on 2 sides (width 6 mm) allow the attachment of trusses, clipboards, attachments and superstructures along the entire length of the leg.

The SNT system is used for industrial workstations, small tables, control room workstations, etc..

The SNT three-stage single column consists of three anodized aluminum profiles, which are guided by plastic glides. The inner profiles are moved by an internal spindle drive.

Up to 4 lifting columns can be connected to one SCT control box and operated synchronously.

Technical Data

- Max. press. load for 1 lifting col. 150 kg
- Max. press. load for 2 lifting col. 300 kg
- Max. press. load for 3 lifting col. 450 kg
- Max. press. load for 4 lifting col. 600 kg

- Max. tensile load per lifting col. 5 kg

- Max. static bending moment Mbxstat = 1'000 Nm
Mbystat = 750 Nm
- Max. dyn. bending moment Mbxdyn = 600 Nm
Mbydyn = 300 Nm

- Lifting speed 25 mm/s
- Stroke length 700 mm
- Installation length 560 mm

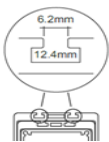

T-Slot Stone:
126.00495 [with M6-thread]

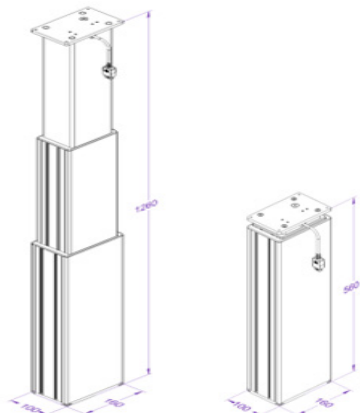



Lifting system SN

- 1430 EU** Art. No. 911.40001 (1 Lifting column)
- 1440 EU** Art. No. 911.40002 (1 Lifting column)
- 2430 EU** Art. No. 911.40003 (2 Lifting columns)
- 2440 EU** Art. No. 911.40004 (2 Lifting columns)
- 1430 CH** Art. No. 911.40101 (1 Lifting column)
- 1440 CH** Art. No. 911.40102 (1 Lifting column)
- 2430 CH** Art. No. 911.40103 (2 Lifting columns)
- 2440 CH** Art. No. 911.40104 (2 Lifting columns)

T-Slots on 2 sides (width 6 mm) allow the attachment of trusses, clipboards, attachments and superstructures along the entire length of the leg.

The SN system is used for industrial workstations, small work tables, control room workstations, assembly desks, assembly plants, office desks and in general furniture and mechanical engineering.

The SN lifting column consists of two anodised aluminium profiles, which are guided by a patented glide system. The inner profile is moved by an internal spindle drive.

Up to 4 columns can be connected to one control box and operated synchronously.

Technical Data

- Max. press. load for 1 lifting col. 200 kg / 300 kg
- Max. press. load for 2 lifting col. 400 kg / 600 kg
- Max. press. load for 3 lifting col. 400 kg / 600 kg
- Max. press. load for 4 lifting col. 1'000 kg

- Max. tensile load per lifting col. 5 kg

- Max. static bending moment Mbxstat = 900 Nm
Mbystat = 600 Nm
- Max. dyn. bending moment Mbxdyn = 200 Nm
Mbydyn = 300 Nm

- Lifting speed 6-8 oder 12 mm/s
- Stroke length 300 oder 400 mm
- Installation length 530 oder 630 mm

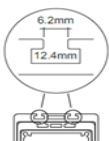

T-Slot Stone:
126.00495 (with M6-thread)

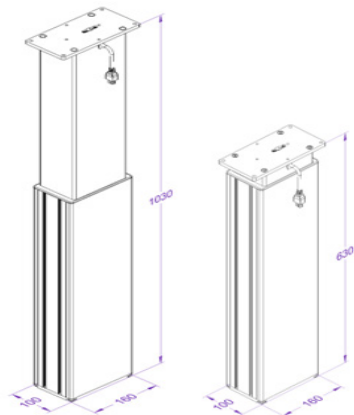

LIFTING COLUMN S0



Lifting system S0

- 1430 EU** Art. No. 912.40001 (1 Lifting column)
- 1440 EU** Art. No. 912.40002 (1 Lifting column)
- 2430 EU** Art. No. 912.40003 (2 Lifting columns)
- 2440 EU** Art. No. 912.40004 (2 Lifting columns)
- 1430 CH** Art. No. 912.40101 (1 Lifting column)
- 1440 CH** Art. No. 912.40102 (1 Lifting column)
- 2430 CH** Art. No. 912.40103 (2 Lifting columns)
- 2440 CH** Art. No. 912.40104 (2 Lifting columns)

T-Slots on 4 sides (width 6 mm) allow the attachment of trusses, clipboards, attachments and superstructures along the entire length of the leg.

The S0 system is used for industrial workstations, small work tables, control room workstations, assembly desks, assembly plants, office desks and in general furniture and mechanical engineering.

The S0 lifting column consists of two anodised aluminium profiles, which are guided by an patented glide system. The inner profile is moved by an internal spindle drive.

Up to 4 columns can be connected to one control box and operated synchronously.

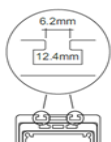

T-Slot Stone:
126.00495 (with M6-thread)

Technical Data

- Max. press. load for 1 lifting col. 200 kg / 300 kg
- Max. press. load for 2 lifting col. 400 kg / 600 kg
- Max. press. load for 3 lifting col. 400 kg / 600 kg
- Max. press. load for 4 lifting col. 1'000 kg

- Max. tensile load per lifting col. 5 kg

- Max. static bending moment Mb_{xstat} = 350 Nm
- Max. dyn. bending moment Mb_{xdyn} = 200 Nm
- Mb_{ystat} = 350 Nm
- Mb_{ydyn} = 200 Nm

- Lifting speed 6-8 oder 12 mm/s
- Stroke length 300 oder 400 mm
- Installation length 530 oder 630 mm

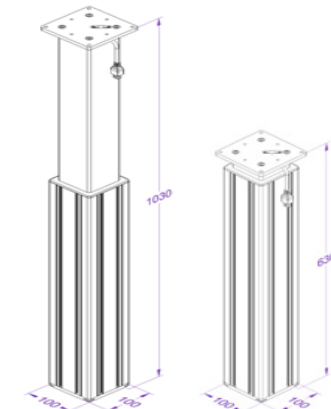

LIFTING COLUMN SF

The SF lifting column is ideal for height-adjustable assembly workstations with two table columns that do not require a load capacity of more than 200 kg. It moves up and down at a **lifting speed of 20 mm/s**.

Lifting system SF

2230 EU Art. No. 909.61003

2240 EU Art. No. 909.61004

2230 CH Art. No. 909.61103

2240 CH Art. No. 909.61104

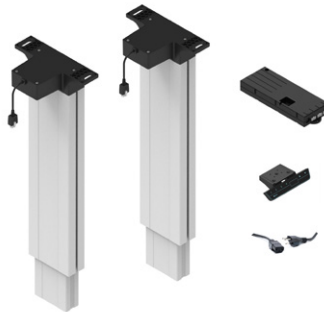

Complete screw jack system SF with control, hand switch and power cable EU or CH.

- Control of 2 spindle lifting columns
- Max. load 200 kg
- Lifting speed 20 mm/s
- Max. stroke 300 or 400 mm

Frame SF

2230 EU Art. No. 909.71003

2240 EU Art. No. 909.71004

2230 CH Art. No. 909.71103

2240 CH Art. No. 909.71104



Complete SF frame with control box, manual switch, telescopic crossbar, plate support, table foot with adjustable feet and power cable EU or CH.

- Max. load 200 kg
- Lifting speed 20 mm/s
- Max. stroke 300 or 400 mm
- Telescopic Cross bar 960 - 1610 mm

24 V CONTROL EXCHANGEABLE BATTERY

With the battery solution, transport trolleys, assembly tables, side tables or similar items can be moved flexibly from A to B and can be adjusted in height.

The 24 V control is operated by an exchangeable battery. The battery can be mounted under the table with a holder. When the battery is empty, it can be recharged in the battery charging station. The charging time is 6 h.

Operation with hand switch Memory.

Lifting system SL EU/CH 12 battery

2430 Art. No. 901.21516 (2 Lifting columns)

2440 Art. No. 901.21517 (2 Lifting columns)



Complete SL screw jack system with control, interchangeable battery, -holder, -charging station and hand switch.

- Max. load 300 kg
- Max. stroke 300 mm
- Lifting speed max. 7.5 mm/s

Other battery solutions for SK, SM, SN and SO lifting systems on request.

Lifting system SLA.3 EU/CH 12 battery

4330 Art. No. 903.42536 (4 Linear units)

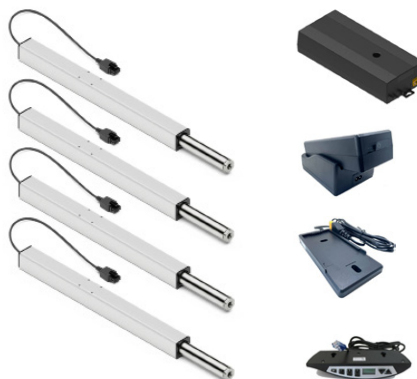

Spindle-driven linear units SLA with control, exchangeable battery, -holder, -charging station and hand switch.

- Max. load 300 kg
- Max. stroke 300 mm
- Lifting speed max. 8.5 mm/s

Other battery solutions for SLG, SE and SQ lifting systems on request.

24 V CONTROL EXCHANGEABLE BATTERY

With the battery solution, transport trolleys, assembly tables, side tables or similar items can be moved flexibly from A to B and can be adjusted in height.

The 24 V control is operated by an exchangeable battery. The battery can be mounted under the table with a holder. When the battery is empty, it can be recharged in the battery charging station. The charging time is 6 h.

Operation with hand switch Memory.

Lifting system SNT EU 12 battery
1770 Art. No. 911.51501 (1 Lifting columnn)



Complete SNT screw jack system with control, interchangeable battery, -holder, -charging station and hand switch.

- Max. load 150 kg
- Max. stroke 700 mm
- Lifting speed max. 25 mm/s

24 V CONTROL EXCHANGEABLE BATTERY

Control box SCT4 iSMPS 24V

Art. No. 124.4xx9x



Control:

- Number of motor connections 1 - 4
- Output power 240 W
- Output voltage 24 V
- Output current 10 A
- Input voltage 25.2 V
- Dimensions (L x W x H) 309 x 120 x 55 mm

Exchangeable battery 10A

Art. No. 124.00271



Exchangeable battery:

- Max. discharge current 10 A
- Capacity 6'000 mAh
- Technology Li-Ion

Holder for exchangeable battery 10A

Art. No. 124.00272



The holder for the exchangeable battery is required for the power supply of the SCT4 24 V controller.

Charging station for exchangeable battery 10A

Art. No. 124.00274



The charging station is required to charge the exchangeable battery 10A.

Control box SCT4 iSMPS 24V with exchangeable battery

Art. No. 124.9xx9x

Set consisting of:

- 124.4xx9x Control box SCT4 iSMPS 24V
- 124.00271 Exchangeable battery 10A
- 124.00272 Holder for exchangeable battery 10A
- 124.00274 Charging station for exchangeable battery 10A
- 124.00281 Hand switch memory T6

LIFTING COLUMN SK

Mounting grooves on 4 sides



Lifting Column SK

1430 Art. No. 910.00003

1440 Art. No. 910.00004

1330 Art. No. 910.00103

1340 Art. No. 910.00104

The **mounting grooves on 4 sides** (width 8 mm) allow the attachment of traverses, intermediate shelves and superstructures on the entire length of the leg.

The SK system is used for assembly tables, assembly systems, office desks and in general furniture and machine construction.

The SK lifting column consists of two colorless anodized aluminum profiles guided by plastic glides. The inner profile is moved by an internal spindle drive.

Up to 4 spindle lifting columns can be connected to one control box and operated synchronously.

The SK lifting column can be combined with the SL and SM lifting columns.

Technical data

- Max. load capacity for 1 lifting column 200 kg / 300 kg
- Max. load capacity for 2 lifting column 400 kg / 600 kg
- Max. load capacity for 3 lifting column 400 kg / 600 kg
- Max. load capacity for 4 lifting column 1'000 kg
- Max. static bending moment Mb_{xstat} = 1'200 Nm
- Mb_{ystat} = 450 Nm
- Max. dyn. bending moment Mb_{xdyn} = 550 Nm
- Mb_{ydyn} = 200 Nm
- Stroke speeds 6-8 or 12 mm/s
- Stroke length 300 oder 400 mm
- Installation length A 530 oder 630 mm

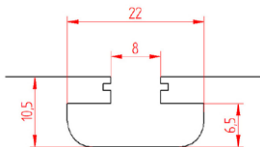

Slot stones:

142.00217 (with M6-thread)

142.00218 (with M8-thread)

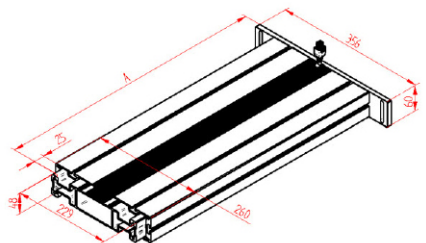

LIFTING COLUMN SL WITH 20 MM/S LIFTING SPEED



Lifting column SL

1830 Art. No. 901.00203

1840 Art. No. 901.00204

New product in our SL lifting column line with a **lifting speed of 20 mm/s**.

The SL system is used for assembly tables, assembly systems, office desks and in general furniture and machine construction.

The mounting grooves on 3 sides (width 8 mm) allow the attachment of traverses, intermediate shelves and superstructures on the entire length of the leg.

The SL lifting column consists of two colorless anodized aluminum profiles guided by plastic glides. The inner profile is moved by an internal spindle drive.

Up to 3 spindle lifting columns can be connected to one control box and operated synchronously.

Technical data

- Max. load capacity for 1 lifting column 75 kg
- Max. load capacity for 2 lifting column 150 kg
- Max. load capacity for 3 lifting column 150 kg

- Max. static bending moment Mbxstat = 1'200 Nm
- Max. dyn. bending moment Mbxdyn = 550 Nm
Mbydyn = 200 Nm

- **Stroke speeds** 20 mm/s
- Stroke length 300 or 400 mm
- Installation length A 530 or 630 mm

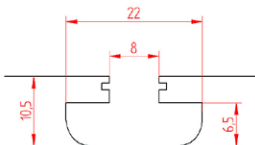

Slot stones:
142.00217 (with M6-thread)
142.00218 (with M8-thread)



COMPLETE SYSTEMS

ORDERABLE VIA WEBSHOP

COMPLETE SYSTEMS

Lifting system SL

2430 EU Art. No. 901.20033-PP

2440 EU Art. No. 901.20034-PP

2430 CH Art. No. 901.20083-PP

2440 CH Art. No. 901.20084-PP

[Purchase in the online shop!](#)



Complete spindle lifting system SL with control box, hand switch and power cable EU or CH. Ready to ship.

- Control of 2 columns
- Max. load 400 kg
- Lifting speed 12 mm/s
- Max. stroke 300 or 400 mm

Packaging:

- Carton box 660 x 367 x 165 mm

Frame SL-2

2430 EU Art. No. 901.20033-PP

2440 EU Art. No. 901.20034-PP

2430 CH Art. No. 901.20083-PP

2440 CH Art. No. 901.20084-PP

Each system must be ordered with the article **901.91000-PP**.

[Purchase in the online shop!](#)



Complete table base frame with spindle drive. With hand switch and power cable EU or CH. Ready to ship.

- Max. load 400 kg
- Lifting speed 12 mm/s
- Max. stroke 300 or 400 mm

Packaging:

- Carton box 660 x 367 x 165 mm
- Carton box 680 x 290 x 230 mm

Lifting system SM

2430 EU Art. No. 902.20033-PP

2440 EU Art. No. 902.20034-PP

2430 CH Art. No. 902.20083-PP

2440 CH Art. No. 902.20084-PP

[Purchase in the online shop!](#)



Complete spindle lifting system SM with control box, hand switch and power cable EU or CH. Ready to ship.

- Control of 2 columns
- Max. load 400 kg
- Lifting speed 12 mm/s
- Max. stroke 300 or 400 mm

Packaging:

- Carton box 660 x 367 x 165 mm

Frame SM-2

2430 EU Art. No. 902.20033-PP

2440 EU Art. No. 902.20034-PP

2430 CH Art. No. 902.20083-PP

2440 CH Art. No. 902.20084-PP

Each system must be ordered with the article **901.92000-PP**.

[Purchase in the online shop!](#)



Complete table base frame with spindle drive. With control box, hand switch and power cable EU or CH. Ready to ship.

- Max. load 400 kg
- Lifting speed 12 mm/s
- Max. stroke 300 or 400 mm

Packaging:

- Carton box 660 x 367 x 165 mm
- Carton box 680 x 290 x 230 mm

Lifting system SLA

4330 EU Art. No. 903.42036-PP

4340 EU Art. No. 903.42037-PP

4330 CH Art. No. 903.42136-PP

4340 CH Art. No. 903.42137-PP

[Purchase in the online shop!](#)



Linear units SLA with spindle drive and control box, hand switch, rubber feet and power cable EU or CH. Ready to ship.

- Control of 4 linear units SLA 1330
- Max. load 600 kg
- Lifting speed 9 mm/s
- Max. stroke 300 mm or 400 mm

Packaging:

- Carton box 760 x 260 x 180 mm

COMPLETE SYSTEMS

Lifting system SLG

4330 EU Art. No. 904.42036-PP

4330 CH Art. No. 904.42136-PP

[Purchase in the online shop!](#)



Linear units SLG with spindle drive and control box, hand switch, rubber feet and power cable EU or CH. Ready to ship.

- Control of 4 linear units SLG
- Max. load 600 kg
- Lifting speed 9 mm/s
- Max. stroke 300 mm

Packaging:

- Carton box 760 x 260 x 180 mm

Lifting system SQ

4330 EU Art. No. 907.42036-PP

4330 CH Art. No. 907.42136-PP

[Purchase in the online shop!](#)



Complete spindle lifting system with 4 legs, control box, hand switch, rubber feet and power cable EU or CH. Ready to ship.

- Control of 4 linear units SQ
- Max. load 600 kg
- Lifting speed 9 mm/s
- Max. stroke 300 mm

Packaging:

- Carton box 760 x 260 x 180 mm

Lifting system LA

300 mm, Art. No. 4-LA-350-300-MAN1-F1-SKM-PP

300 mm, Art. No. 4-LA-350-300-CH2-F1-SKM-PP

[Purchase in the online shop!](#)

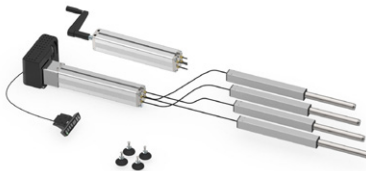

Linear units LA with hydraulic drive, with handcrank (HK) or motor (M), control box, hand switch, rubber feet and power cable EU or CH. Ready to ship.

- Control of 4 linear units
- Max. load 350 kg
- Lifting speed 5 mm/crank rotation or 15 mm/s (with motor)
- Stroke 300 mm

Packaging:

- Carton box 1200 x 350 x 250 mm



ADDITIONAL
ARTICLE

TABLE BASE FC 650 4.0



Table base FC 650 4.0

Silver Art. No. 116.00077

Anthracite Art. No. 116.00078

The table base FC 4.0 is used as a frame for an office desk or a simple assembly table. The table system can be assembled in a few minutes. As an accessory, we recommend the cable canal for optimum cable management and our PC holder.

[Purchase in the online shop!](#)

Technical specifications

- Max. load 100 kg
- Max. dyn. bending moment 200 Nm
- Stroke length 660 mm (605 - 1265 mm)
- Lifting speed 40 mm/s
- Voltage 230 V
- Power cable EU, CH
- Dimension outer profile 90 x 60 mm
- Plate length 1160 - 2200 mm
- Plate depth 550 - 800 mm
- Color: silver or anthracite powder coated

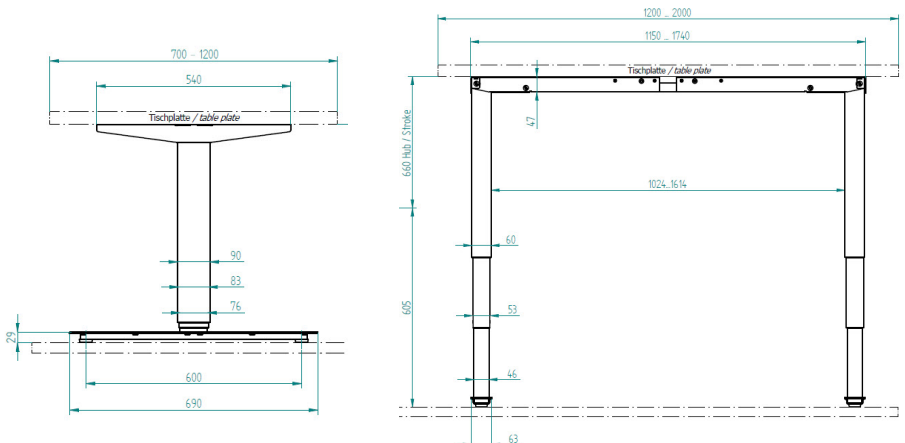

CABLE DUCT FC 650 4.0



Cable duct FC 650 4.0
Black Art. No. 116.00081

Practical cable channel for mounting on table base FC 650 4.0 for optimal cable management. This minimizes tripping hazards and reduces the risk of accidents. In addition, the cable channel protects the electronic devices from cable damage.

Technical specifications

- Max. length 1684 mm
- Min. length 938 mm
- Foldable and telescopic
- Color: black

[Purchase in the online shop!](#)

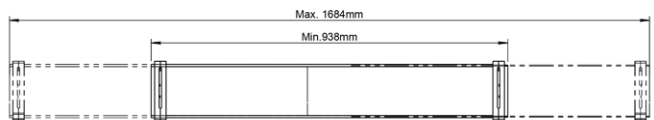
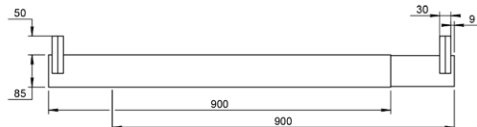
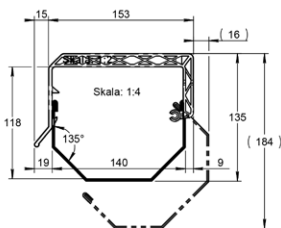
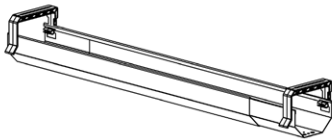

LIFTING CASTOR HR



Lifting castor set HR 4803 notox

Art. No. 501.10101-PP

The system consists of 4 castors with hydraulic driven levelling feet. Through the rotary motion of the hand crank the hydraulic oil is pressed out of the pump and flows through the hydraulic tubing into the connected levelling foot. The system functions independently of load and the 4 castors operate completely synchronously. Each lifting castor is equipped with 3 m hydraulic tubing. The tubing can be cut to the required size and be easily connected to the pump. On request, up to 10 lifting castors can be operated with one pump.

Packaging and Accessories

The set with 4 lifting castors and hydraulic pump is packed up in a cardboard box (590 x 395 x 150 mm) and contains the following accessories:

- 5 clamping rings
- 1 connection screw (spare part)
- 1 magnet
- 1 tubing cutter
- 1 ring spanner
- Assembly and operating instructions

Technical specifications

The castor with polyurethane wheels is made of injection-moulded, thermoplastic elastomer and has very low abrasion and low rolling friction with 94° Shore A

- Wheel-Ø 100 mm
- Wheel width 32 mm
- Total height 150 mm
- Plate size 100 x 85 mm
- Bearing castor: ball-bearing
- Max. system load per system of 4: 750 kg
- Stroke 10 mm
- Tubing length 3 m
- Food grade hydraulic fluid

[Purchase in the online shop!](#)

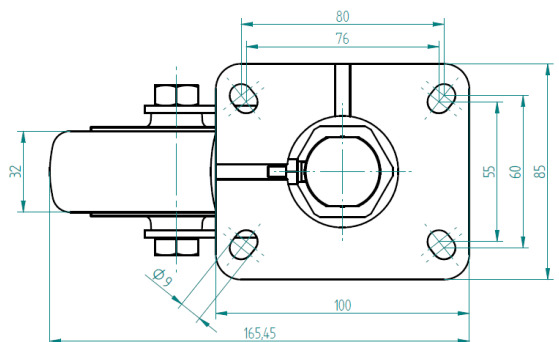
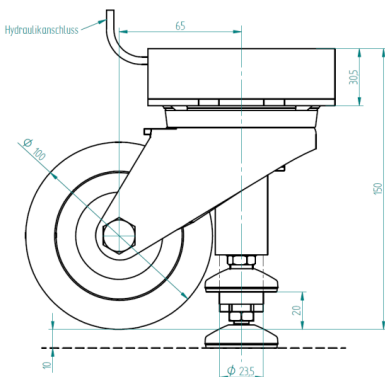



Linear unit LH with hose

- LH 1440** Art. No 306.10004
- LH 1450** Art. No. 306.10005*
- LH 1830 V** Art. No. 306.10013
- LH 1840** Art. No. 306.10014
- LH 1430 V** Art. No. 306.10023
- LH 1440 V** Art. No. 306.10024*

*Was taken out of the assortment from the end of 2024!

Thanks to its slimline design, the linear unit LH is suitable for installation in a square tube. It is mainly used when large lifting distances are required. Four M5 screw threads are provided to mount the linear unit. The linear unit LH consists of two steel tubes. The galvanised guide tube is supported on bearings. The lifting movement is effected by hydraulic cylinders. The height is adjusted by means of a hydraulic pump operated by a hand crank or an electric drive unit.

Accessories

- Adjustable feet made of rubber or aluminium
- Locking castors

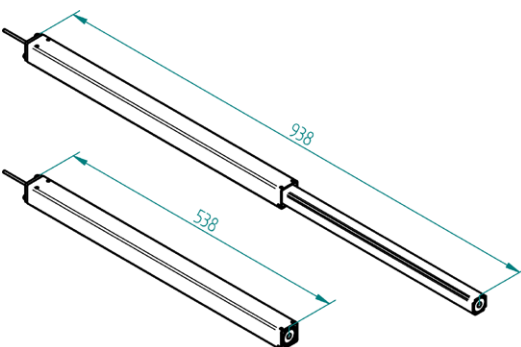

Technical specifications

Linear unit with integrated hydraulic cylinders. Slimline design, suitable for large lifting distances.

- Max. load: 150 kg or 250 kg
- Stroke length 400 or 500 mm
- Max. static bending moment $M_b = 200 \text{ Nm}$
- Max. dynamic bending moment $M_{bdyn} = 70 \text{ Nm}$
- Max. system load: depending on pump
- Incl. tubing 4m pre-mounted
- Synchronous control of up to 10 table legs
- Color: RAL 9006, white aluminium, coated
- Food grade hydraulic fluid



LIFTING SYSTEMS SL FIX

Lifting system SL FIX

2440 Art. No. 901.91005-PP



Columns SL FIX. For workplaces that do not or rarely need to be adjusted in height. Ready to ship.

- Max. load 300 kg
- Fitting length 630 - 1030 mm
- Manually adjustable in 50 mm steps

Packaging:

- Carton box 660 x 367 x 165 mm

Frame SL FIX

2440 Art. No. 901.91005-PP + 901.91000-PP

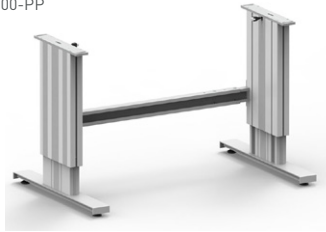

Complete table base frame SL-2 FIX. For tables that do not or rarely need to be adjusted in height. Ready to ship.

- Max. load 300 kg
- Fitting length 630 - 1030 mm
- Manually adjustable in 50 mm steps

Packaging:

- Carton box 660 x 367 x 165 mm
- Carton box 680 x 290 x 230 mm



HAND CRANK &
ELECTRONIC
ACCESSORIES

HAND CRANKS

KIT Hand crank H

Art. No. 113.00105-PP

Available from January 2025!

Purchase in the online shop
from 2025!

NEW



The foldable and removable hand crank is mounted on the pump shaft using the click function instead of drilling and pinning.

Application:

- Pumps PA, PB, PF

KIT Hand crank foldable

Art. No. 113.00005-PP

Purchase in the online shop!



Was taken out of the assortment from the end of 2024 and replaced by article 113.00105-PP!

The foldable hand crank is mounted to the pump shaft with a roll pin. The hand crank is not removable, but it is possible to fold it underneath the table. If the hand crank is ordered as a single part, the roll pin will be sent with the package.

Application:

- Pumps PA, PB, PF

Hand crank foldable RF

Art. No. 113.00090



Was taken out of the assortment from the end!

It is similar to the foldable hand crank. All steel parts are made of stainless steel.

Application:

- Pumps PA, PB, PF

Hand crank removable

Art. No. 113.00013



Was taken out of the assortment from the end of 2024 and replaced by article 113.00105-PP!

It is possible to remove the hand crank after the height adjustment. This hand crank is only suitable with the pump shaft type «A».

Application:

- Pumps PA, PB, PF

Hand crank foldable W cpl.

Art. No. 113.00065



Was taken out of the assortment from the end of 2024 and replaced by article 113.00105-PP!

The foldable hand crank **W** is pinned with a grub screw onto the pump shaft type **W**. The grub screw and woodruff key will be sent with the package.

Application:

- Pumps PA, PB, PF

HAND CRANKS

Hand crank with counter
Available upon request



Was taken out of the assortment from the end of 2024!

To show the working height of Ergoswiss Systems with hand crank drive. Can be retrofitted as a kit in already installed systems.

Application:

- Hydraulic lifting systems with hand crank

Hand crank 90° cpl.
Art. No. 113.00070

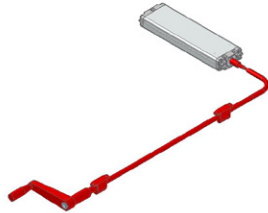

Was taken out of the assortment from the end of 2024 and replaced by article 113.00105-PP!

With the flexible 90° crankshaft and a straight crankshaft it is possible to mount the hand crank and the pump in a 90° angle. The straight crankshaft is 1m long, it can be shorten to your needed length.

Application:

- Pumps PA, PB, PF (only for typ W)

KIT Friction clutch 10 Nm cpl.
Art. No. 113.30022-PP
Available from January 2025!

[Purchase in the online shop from 2025!](#)

NEW



If you want to protect your system from overload, you need to use the safety clutch. By using the safety clutch it is not possible to create a higher torque than 10Nm with the hand crank.

Application:

- Pumps PA, PB, PF

KIT Friction clutch 10 Nm cpl.
Art. No. 113.00022-PP

[Purchase in the online shop!](#)



Was taken out of the assortment from the end of 2024 and replaced by article 113.30022-PP!

If you want to protect your system from overload, you need to use the safety clutch. By using the safety clutch it is not possible to create a higher torque than 10Nm with the hand crank.

Application:

- Pumps PA, PB, PF (only for typ W)

Crank body
Art. No. 128.00002-PP

[Purchase in the online shop!](#)



Spare part for hand crank 113.00005/13/65/70/90

HAND SWITCH COMPACT

Hand switch Compact Memory HSU

Art. No. 124.00223-PP

[Purchase in the online shop!](#)



The hand switch memory can save up to four height positions additionally to the normal up and down function.

- 4 memory buttons
- Cable length 1.9 m
- Can be slid underneath the table
- Softclick feeling of pressure

Application:

- Hydraulic lifting systems with electric drive (standard hand switch)
- Spindel lifting systems with compact drive

Hand switch Compact Memory **modified**

Art. No. 124.00249

[Purchase in the online shop!](#)

NEW



The hand switch memory can save up to four height positions additionally to the normal up and down function.

- 4 memory buttons
- Cable length 1.9 m
- Can be slid underneath the table
- Softclick feeling of pressure
- **Modified: increased water protection**

Application:

- Hydraulic lifting systems with electric drive (standard hand switch)
- Spindel lifting systems with compact drive

Hand switch Compact up-down Front

Art. No. 124.00059



- Mounting underneath the table plate
- Ergonomic design
- Static installation
- Softclick feeling of pressure
- Up/Down function
- Cable length 1.8 m

Application:

- Hydraulic systems with motor unit
- Spindle lifting system with control box compact (standard hand switch)

Radio remote control Compact 2.0

Art. No. 124.00128



Remote control consisting of radio transmitter (incl. battery and holder), radio receiver, hand-held remote control and operating instructions.

Application:

- Hydraulic lifting systems with electric drive
- Spindel lifting systems with compact control box

Foot switch Industrial SCT cpl.

Art. No. 124.00160

NEW



- Cable length 2 m

Application:

- Spindel lifting systems with SCT control box

HAND SWITCH COMPACT

Foot switch compact cpl.

Art. No. 124.00170



- Cable length 2 m

Application:

- Hydraulic lifting systems with electric drive
- Spindle lifting systems with compact control box

HAND SWITCH COMPACT

Control cable Compact Art. No. 124.00136



A PLC or a hand switch of your choice can be attached to the control cable.

- Cable length 2 m

Application:

- Hydraulic lifting systems with electric drive
- Spindle lifting systems with compact control box

Compact Split cable for hand switch Art. No. 124.00070



With the split cable it is possible to connect two hand switches to the control box.

- Cable length 200 mm

Application:

- Hand switch for compact control box

Extension cable for hand switch Compact Art. No. 124.00071



With the extension cable it is possible to extend the cable of the hand switch.

- Cable length 1 m
- Maximum of 3 extension cables in series

Application:

- Hand switch for compact control box

Motor cable PXD.2 Compact Art. No. 124.00229

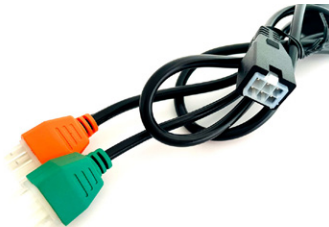

The motor cable connects the motor type «D» with the control box.

- Cable length 1 m

Application:

- Motors PAD, PBD, PFD

Motor extension cable SCT/Compact Art. No. 124.00137



The motor extension cable can be used to extend the motor cable of a PXD motor or a spindle lifting system.

- Cable length 1.2 m
- 2 cables are needed to extend the motor PXD
- Maximum of 5 extension cables in series

Application:

- Hydraulic systems with electric drive
- Spindle lifting systems with compact and SCT controls

Motor cable SX

Art. No. 124.00151



- Cable length 1.7 m

Application:

- Spindle lifting systems with STC/compact control boxes
- lifting column SL, SM

SYNC-2 Cabel compact

Art. No. 124.00088



With the SYNC-2 cable it is possible to synchronize 2 control boxes. Both control boxes run in a parallel mode.

- Cable length 550 mm

Application:

- Systems with compact control boxes

SYNC-4 Cabel compact

Art. No. 124.00089



With this cable it is possible to synchronize 2, 3 or 4 compact control boxes. All 2, 3 or 4 lifting systems run in a parallel mode.

- Cable length 1.8 m
- 1 cable per control box is needed (4 control boxes = 4 cables)

Application:

- Systems with compact control boxes

Safety strip Compact cpl.

Art. No. 124.00105



By attaching the squeeze line to a possible squeeze zone, the system immediately stops when the contact hose or crushed.

- Cable length 2.5 m
- Contact hose length selectable 10 cm - max. 5 m (confectioning in 50 mm steps)

Application:

- Systems with compact control box

Split cabel sensor compact

Art. No. 124.00084



The split cable sensor is needed to use two squeeze lines or a squeeze line and a sync cable.

Application:

- Squeeze lines or sync cable for compact control box

Control Box compact-3-eco preprogrammed

230 V Art. No. on request

110 V Art. No. on request



This is the standard control box for a hydraulic system with motor unit or spindle lifting system.

- Supply Voltage 230 V/110 V
- Power 360 W
- Standby power < 0.6 W
- Port for hand switch
- For spindle lifting system: 1-3 motor Plug detection

Application:

- Hydraulic lifting system with motor unit (230 V/110V)
- Spindle lifting system with compact control box (230 V/110V)

CB for continous operation compact

Art. No. 124.00075



The continuous operating control box is a product to automatically adjust table systems under test conditions.

- Manual operation with hand switch
- Automatic mode
- Memory mode
- Up/Down mode

Hand switch SCT Memory T6

Art. No. 124.00281-PP

[Purchase in the online shop!](#)



- 3 memory positions
- Fixed assembly
- Cable length 2 m

Application:

- Systems with SCT control boxes

Hand switch SCT up - down

Art. No. 124.00280



- Fixed installation
- Up/down function
- Cable length 2 m

Application:

- Systems with SCT control boxes

SCT compact extension cable 1.2m motor

Art. No. 124.00137



Extension cable for SCT/Compact Motor. Motor cables of lifting systems with Molex plugs can be extended with this cable.

- Cable length 1.2 m
- Max. 5 extension cables in series

Application:

- Spindle lifting systems with STC/compact control boxes

Extension cable Hand switch SCT 1m

Art. No. 124.00290



Extension cable for hand switch SCT 1m

- Cable length 1 m
- Max. 3 extension cables in series

Application:

- Systems with SCT control boxes

Motor cable SX

Art. No. 124.00151



- Cable length 1.7 m

Application:

- Spindle lifting systems with STC/compact control boxes
- lifting column SL, SM

ELECTRONIC ACCESSORIES SCT

Control cable SCT

Art. No. 124.00279



The control cable can be connected to a PLC or a hand switch.

- Cable length 2 m
- Only lifting up/down can be controlled
- Memory positions are not controllable with a PLC

Application:

SYNC-2 cable SCT

Art. No. 124.00183



The cable connects 2 SCT controllers with each other. In this way, 2 lifting systems can be operated in parallel.

- Cable length 4 m

Application:

- Systems with SCT control

Safety strip SCT cpl.

Art. No. 124.00157



By attaching the safety strip to a possible crushing zone, the system stops immediately when the contact hose is being driven up or crushed.

- Cable length 2.5 m
- Contact hose length selectable 10 cm - max. 5 m (confectioning in 50 mm steps)

Application:

- Systems with SCT control boxes

Control box SCT2 iSMPS preprogrammed

230 V Art. No. on request



Control box for spindle lifting systems.

- Supply voltage 230 V
- Power 280 VA
- Standby power < 0.5 W
- Port for hand switch
- 1 - 2 ports for motor units

Application:

- Spindle lifting systems SE, SK, SL, SM, SQ, SLA, SLG

Control box SCT4 iSMPS preprogrammed

230 V Art. No. on request

110 V Art. No. on request



Control box for spindle lifting systems.

- Supply voltage 230 V / 110 V
- Power 340 VA
- Standby power < 0.5 W
- Port for hand switch
- 1 - 4 ports for motor units
- Synchronous operation up to 8 lifting systems possible with SYNC-2 cable SCT

Application:

- Spindle lifting systems SE, SK, SL, SM, SQ, SLA, SLG

Power cable EU

3m Art. No. 124.00142

5m Art. No. 124.00149



2 pole power cable with an European plug.

- Voltage 230 V
- Plug type CEE 7/7
- Cable length 3 m or 5 m

Application:

- Systems with compact control box

Power cable CH

3m Art. No. 124.00143

5m Art. No. 124.00148



3 pole power cable with a Swiss plug.

- Voltage 230 V
- Plug type SEV 1011
- Cable length 3 m or 5 m

Application:

- Systems with compact control box

Power cable UK 3m

Art. No. 124.00144

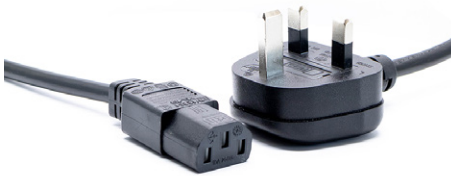

3 pole power cable with an English plug.

- Voltage 230 V
- Plug type Commonwealth
- Cable length 3 m

Application:

- Systems with compact control box

Power cable US 3m

Art. No. 124.00145



3 pole power cable with an American plug.

- Voltage 110 V
- Plug type NEMA 5 - 15
- Cable length 3 m

Application:

- Systems with compact control box 110 V



MOUNTING ACCESSORIES

MOUNTING ACCESSORIES

Bracket D6

Art. No. 113.00029



Alternative mounting option for the piston rod of our cylinders.

- Stud diameter 6 mm
- Max. load 2500 N

Application:

- Cylinder types CB, CD and CI

Bracket D8

Art. No. 113.00030



Alternative mounting option for the connection head of our cylinders.

- Stud diameter 8 mm
- Max. load 3500 N

Application:

- Cylinder types CD and CE

Mounting plate type A cpl.

Art. No. 113.00003-PP

Mounting plate type D cpl.

Art. No. 113.00125-PP

[Purchase in the online shop!](#)

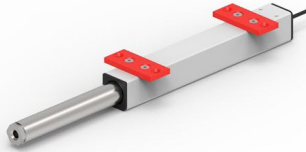

Mounting plate for linear units.

- Plate size 30 x 70 mm (A), 30 x 80 mm (D)
- Ø 5,8 mm drill hole

Application Typ A:

- Linear units LA, LD, LH, SLA

Application Typ D:

- Linear units LG, SLG

Mounting plate type B cpl.

Art. No. 113.00004-PP

Mounting plate type E cpl.

Art. No. 113.00126-PP

[Purchase in the online shop!](#)

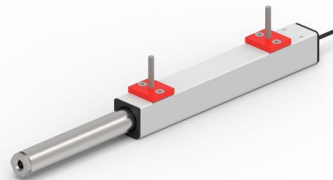

Mounting plate for linear units.

- Plate size 30 x 35 mm (B), 30 x 45 mm (E)
- Incl. countersunk screw M6 x 40

Application Typ B:

- Linear units LA, LD, LH, SLA

Application Typ E:

- Linear units LG, SLG

Mounting plate type C cpl.

Art. No. 113.00039-PP

Mounting plate type F cpl.

Art. No. 113.00127-PP

[Purchase in the online shop!](#)

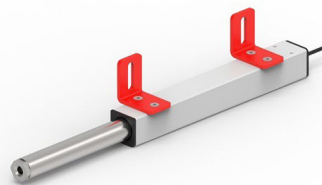

Angle bracket for linear units.

- Angle 90° 50 x 50 x 32 mm (C), 55 x 55 x 32 mm (F)
- Ø 6,9 mm drill hole

Application Typ C:

- Linear units LA, LD, LH, SLA

Application Typ F:

- Linear units LG, SLG

MOUNTING ACCESSORIES

Tube fitting LA 28

Art. No. 113.00054-PP

[Purchase in the online shop!](#)



The tube fitting is used to mount the linear units onto a tube system.

- Tube diameter 28 mm
- ESD conductive

Application:

- Linear units LA, LD, SLA

Drilling template LA and LD

Art. No. 198.00149



The drilling template for the linear units LA and LD is made for an easier installation.

Table leg TA

TA 1440 2P Art. No. 306.00141

TA 1450 2P Art. No. 306.00142

TA 1840 2P Art. No. 306.00134

TA 1850 2P Art. No. 306.00135

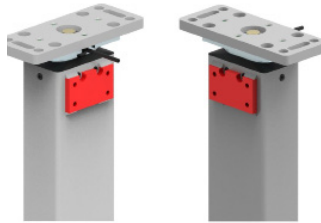

Was taken out of the assortment from the end of 2024!

The table legs TA 2P have got a mounting plate on each side to mount two crossbars to the table leg.

Application:

- Long tables with 5 or more TA legs

Plate carrier TA cpl.

Art. No. 115.00160



For mounting a table plate with a table leg TA.

- Dimensions 416 x 68 x 30 mm

Application:

- Frame TA

Plate carrier TA 550 / 75 cpl.

Art. No. 115.00161

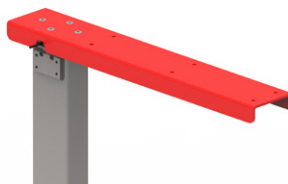

Was taken out of the assortment from the end of 2024!

The plate carrier TA 550/75 can be used, when the table leg TA is mounted against a wall. This way the table plate will get enough support of the long plate carrier.

- Incl. countersunk screw M6 x 10
- Dimensions 550 x 90 x 30 mm

Application:

- Table leg TA

MOUNTING ACCESSORIES

Plate carrier TA-C cpl.
Art. No. 115.00162

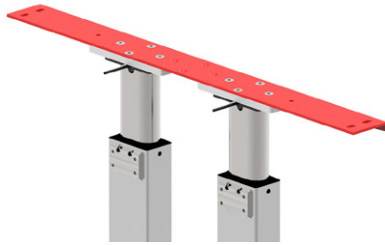

Was taken out of the assortment from the end of 2024!

- For mounting a table plate on tableleg TA.
- Dimensions 700 x 68 x 30 mm

Application:

- Frame TA-C, table leg TA

Angle bracket TA cpl.
Art. No. 127.00075



Was taken out of the assortment from the end of 2024!

The angle bracket is used to anchor the table leg with a wall. The angle bracket is mounted onto the mounting plate with four M6 screws on the table leg TA.

- Incl. Raised countersunk-head screws M6x10
- Dimensions 130/53 x 50 x 3 mm

Application:

- Table leg TA

Cross bar TA/TU/SE cpl.
550 Art. No. 115.00150
750 Art. No. 115.00151
950 Art. No. 115.00152
1150 Art. No. 115.00153
1550 Art. No. 115.00154

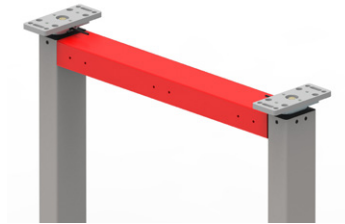

Union joint for TA table legs.

- Dimensions 550, 750, 950, 1150, 1550 x 80 x 50mm

Application:

- Frame TA/TU/SE
- Table leg TA/TU
- Lifting columns SE

Foot plate TA both sides cpl.
Art. No. 127.00138

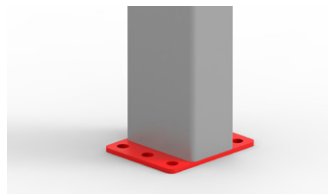

The foot plate TA is used to anchor the table leg on both sides into the ground.

- Incl. countersunk screw M6 x 25
- Dimensions 100 x 80 x 4 mm

Application:

- Table leg TA

Foot plate TA cpl.
Art. No. 127.00033

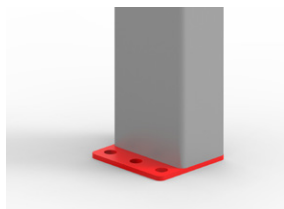

Was taken out of the assortment from the end of 2024!

The foot plate TA is used to anchor the table leg into the ground.

- Incl. flat-head screw M6 x 25
- Dimensions 80 x 75 x 4 mm

Application:

- Table leg TA

MOUNTING ACCESSORIES

Table foot TA-B cpl.
Art. No. 127.00073

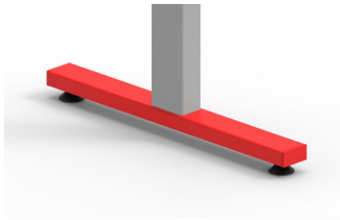

This table foot is mounted to the TA lifting column.
The regulating feet are supplied.

- Dimensions 600 x 60 x 30 mm

Application:

- Lifting column TA

Foot plate TT 360x40
Art. No. 126.00113

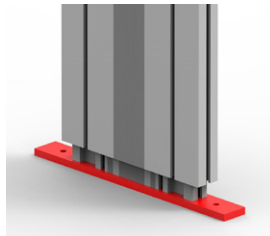

The TT foot plate is mounted to the tableleg TT and can be screwed to the rack or the floor using the two \varnothing 9 mm holes.

- Dimensions 360 x 40 x 10 mm

Application:

- Table leg TT

Foot plate SL 340x60 Slot hole
Art. No. 126.00108

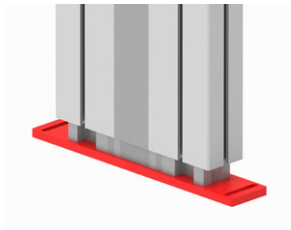

With this foot plate the table leg SK/SL/TL/TT can be mounted onto a crossbar or into the ground.

- Dimensions 340 x 60 x 10 mm

Application:

- Lifting Columns SK, SL, TL, TT

Table foot SK/SL/TL/TT 580 cpl.
Art. No. 115.00550

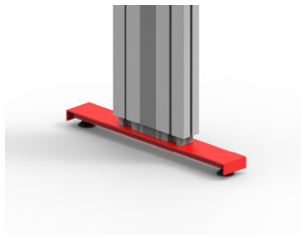

This table foot is mounted to the SK/SL/TL/TT lifting columns.
The regulating feet are supplied.

- Dimensions 580 x 80 x 30 mm

Application:

- Lifting columns SK, SL, TL, TT

Table foot SM/SF/TM 580 cpl.
Art. No. 115.00560

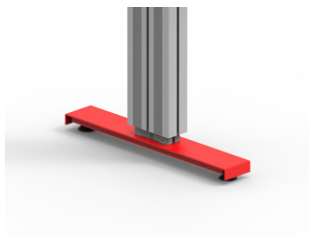

This table foot is mounted to the SM/SF/TM lifting columns.
The regulating feet are supplied.

- Dimension 580 x 90 x 30 mm

Application:

- Lifting columns SM, SF, TM

Table foot SK/SL/TL 680 eccentric cpl.

Art. No. 115.00570

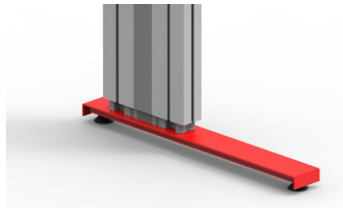

This table foot is mounted to the SL/TL lifting columns.

The regulating feet are supplied.

- Dimensions 680 x 80 x 30 mm
- Table leg is eccentric by 155 mm

Dimensions:

- Lifting columns SK, SL, TL

Table foot SK/SL/TL/TT 680 cpl.

Art. No. 127.00515

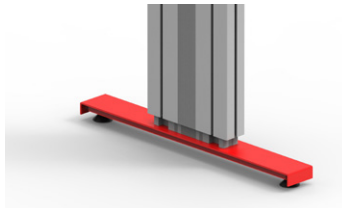

This table foot is mounted to the SK/SL/TL/TT lifting columns.

The regulating feet are supplied.

- Dimensions 680 x 80 x 30 mm

Application:

- Lifting columns SK, SL, TL, TT

Table foot SF/SM/TM 680 cpl.

Art. No. 127.00545

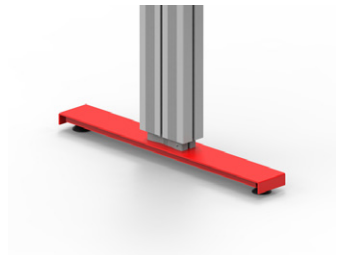

This table foot is mounted to the SF/SM/TM lifting columns.

The regulating feet are supplied.

- Dimension 680 x 90 x 30 mm

Application:

- Lifting columns SF, SM, TM

Foot plate SM 200x60 Slot hole

Art. No. 126.00132

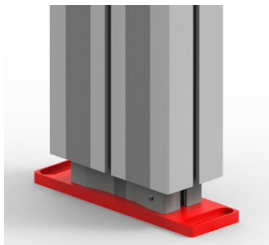

With this foot plate the table leg SF/SM/TM can be mounted onto a crossbar or into the ground.

- Dimensions 200 x 60 x 10 mm

Application:

- Lifting columns SF, SM, TM

Foot plate SM 125x60 M10

Art. No. 127.00329

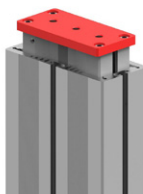

This foot plate can be mounted to the lifting column SF/ SM/TM. With the help of the three M10 threads, adjustable feet or rollers can be added.

- Dimensions 125 x 60 x 10 mm
- ESD-conductive

Application:

- Lifting columns SF, SM, TM

Table plate support SM/TM cpl.

Art. No. 115.00165



For attaching a table top to the SM/TM lifting column.

- Dimensions 416 x 80 x 5 mm

Application:

- Lifting columns SM, TM

Adapter plate SN SNT 40 45 cpl.

Art. No. 115.00177

NEW



Adapter plate for lifting column SN and SNT.

- Dimensions 135 x 160 x 8 mm

Application:

- Lifting columns SN, SNT

Adapter plate SO 40 45 cpl.

Art. No. 115.00178

NEW



Adapter plate for lifting column SO

- Dimensions 120 x 155 x 8 mm

Application:

- Lifting columns SO

Table plate support SN-1/SNT-1/SO-1 cpl.

Art. No. 115.00175

NEW



For attaching a table top to the SN, SNT and SO lifting column.

- Dimensions 450 x 270 x 5 mm

Application:

- Lifting columns SN, SNT, SO

Table foot SN-1/SNT-1 cpl.

Art. No. 115.00176

This table foot is mounted to the SN and SNT lifting columns. The regulating feet are supplied.

- Dimensions 680 x 680 x 30 mm

Application:

- Lifting columns SN, SNT

MOUNTING ACCESSORIES

Telescopic cross bar T8 900-1550

Art. No. 127.00635



Telescopic connecting piece for SF/SK /SL/ SM/TL/ TM and TT lifting columns. The traverse can be easily pushed into the grooves (width 8 mm) of the lifting column and clamped with a hexagonal wrench.

- Dimensions 900 -1550 mm (50 mm grid)
- Connection to small side of the lifting column

Application:

- Lifting columns SF, SK, SL, SM, TL, TM, TT

Telescopic cross bar T8 550-950 - 90°

Art. No. 127.00631

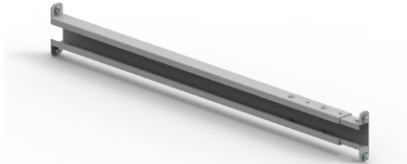

Telescopic connecting piece for SK /SL/ SM/TL/TM and TT lifting columns. The traverse can be easily pushed into the grooves (width 8 mm) of the lifting column and clamped with a hexagonal wrench.

- Dimensions 550 -950 mm (50 mm grid)
- Front connection to the broad side of the lifting column
- Lifting column

Anwendung:

- Lifting columns SK, SL, SM, TL, TM, TT

Telescopic cross bar T8 900-1550 - 90°

Art. No. 127.00632

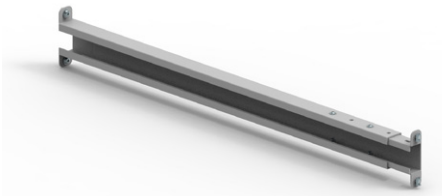

Telescopic connecting piece for SK /SL/ SM/TL/TM and TT lifting columns. The traverse can be easily pushed into the grooves (width 8 mm) of the lifting column and clamped with a hexagonal wrench.

- Dimensions 900 -1550 mm (50 mm grid)
- Front connection to the broad side of the lifting column
- Lifting column
- Lifting column

Anwendung:

- Lifting columns SK, SL, SM, TL, TM, TT

Fastening angle SX 60x60 cpl.

Art. No. 113.00150

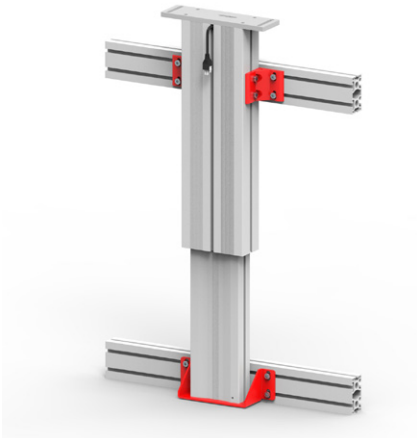

With the fastening angle the SL and SM table legs can be attached to a wall or slot profile.

- Delivery includes 1 angle
- Incl. screws M8
- Incl. T-slot nuts
- For profiles with nut distance 30 to 50 mm

Application:

- Lifting columns SL, SM, TL, TM

Adaptor sheet SM 90°

Art. No. 127.00630



The adaptor sheet is used to mount the inner column profile onto a wall or a T-slot profile.

- Excl. screws (these are supplied with the table leg)
- For profiles with T-slot distance from 30 to 50 mm

Application:

- Lifting columns SM and TM
- Lifting columns SL and TL on request

MOUNTING ACCESSORIES

T-slot nut 11.6 x 4.6 M6

Art. No. 142.00217



- Length 16 mm
- Width 11.6 mm
- Height 4.6 mm
- Height with spring plate 7.6 mm
- Thread M6

Application:

- Ergoswiss T-slot 8

T-slot nut 11.6 x 4.6 M8

Art. No. 142.00218



- Length 16 mm
- Width 11.6 mm
- Height 4.6 mm
- Height with spring plate 7.6 mm
- Thread M8

Application:

- Ergoswiss T-slot 8

T-slot nut 18x12x3.9 M6

Art. No. 126.00495

NEW



- Length 18 mm
- Width 12 mm
- Height 3.9 mm
- Thread M6

Application:

- Ergoswiss T-slot 6
- Lifting columns SNT, SN, SO

T-slot cover strip L730

Art. No. 142.00285



The T-slot cover strip can be clipped into any 8mm t-slot profile and cut to size if required.

- Length 730 mm
- Material PVC
- Color: grey



RUBBER FEET & CASTORS

RUBBER FEET & CASTORS

KIT Rubber foot M10 x 25 RF

Art. No. 113.00006-PP

[Purchase in the online shop!](#)



Rubber foot with thread M10 x 25 and vulcanized rubber coating.

- Incl. M10 counter nut
- System load of 300 kg
- Stainless version

Application:

- Linear units LA, LH, SLA, SLG
- Columns SE, SQ
- Table legs TQ, TU, TA
- Table feet SK, SL, SM, TA, TL, TM, TT

Aluminium foot D50x35

Art. No. 113.00028



There are 3 drill holes which allow to anchor the foot into the ground.

- Incl. M10 counter nut
- 3 x Ø 5,5 mm TK 40
- Stainless version
- Screw shaft M10 x 25 mm

Application:

- Linear units LA, LH, SLA, SLG
- Columns SE, SQ
- Table legs TQ, TU, TA
- Table feet SK, SL, SM, TA, TL, TM, TT

Articulated foot M10x20 RF ESD

Art. No. 113.00056



Adjustable articulated foot for high loads. Thread M10 x 20.

- Max. load : 300 kg
- Stainless version
- ESD: electrostatic discharge

Application:

- Linear units LA, LH, SLA, SLG
- Columns SE, SQ
- Table legs TQ, TU, TA
- Table feet SK, SL, SM, TA, TL, TM, TT

Castor LA 100 cpl.

Art. No. 113.00040



- Roll diameter 100 mm, Height 121 mm
- Screw shaft M10
- Max. system load dynamic: 700 N (by 3 km/h)
- Max. system load static: 1'750 N (at standstill)
- 360° swiveling
- With break

Application:

- Linear units LA, LH, SLA, SLG
- Columns SE, SQ
- Table legs TQ, TU, TA
- Table feet SK, SL, SM, TA, TL, TM, TT

Double castor D50 cpl.

Art. No. 113.00067

Was taken out of the assortment from the end of 2024!



- Roll diameter 50 mm, Height 71 mm
- Incl. fastening screw M10
- Max. system load dynamic: 800 N (by 3 km/h)
- Max. system load static: 2'000 N (at standstill)
- 360° swiveling
- With break

Application:

- Linear units LA, LH, SLA, SLG
- Columns SE, SQ
- Table legs TQ, TU, TA
- Table feet SK, SL, SM, TA, TL, TM, TT

RUBBER FEET & CASTORS

Double castor D75 cpl.

Art. No. 113.00057



- Roll diameter 75 mm, Height 96mm
- Incl. fastening screw M10
- Max. system load dynamic: 1'000 N (by 3 km/h)
- Max. system load static: 2'500 N (at standstill)
- 360° swiveling
- With break

Application:

- Linear unit LA, LH, SLA, SLG
- Columns SE, SQ
- Table legs TQ, TU, TA
- Table feet SK, SL, SM, TA, TL, TM, TT

Castor TA 125 cpl.

Art. No. 113.00033



- Roll diameter 125 mm, Height 165 mm
- Fastening with 4 M6 x 25 countersunk screw
- Max. system load dynamic: 2'500 N (by 3 km/h)
- Max. system load static: 6'250 N (at standstill)
- 360° swiveling
- With break

Application:

- System TA-4

Castor SM 125 cpl.

Art. No. 113.00053



- Roll diameter 125 mm, Height 160 mm
- Fastening with 4 M6 x 20 thread grooving screw
- Max. system load dynamic: 2'500 N (by 3 km/h)
- Max. system load static: 6'250 N (at standstill)
- 360° swiveling
- With break

Application:

- System SM-4 and TM-4

The image features a collection of hydraulic accessories. On the left, there are several blue plastic components, including a large rectangular fitting with a circular opening and a smaller cylindrical piece. On the right, there are several brass fittings, including a large hexagonal nut with a threaded section, a smaller hexagonal nut, and a small cylindrical fitting. The background is a plain white surface.

HYDRAULIC ACCESSORIES

HYDRAULIC ACCESSORIES

Tubing black 4.0x0.9

Art. No. 113.00002



- Outer diameter 4 mm
- Inner diameter 2.2 mm
- Wall thickness 0.9 mm
- Max. operating pressure 100 bar
- Burst pressure 420 bar
- Minimum bending radius 25 mm

Please read the assembly instructions.

Connecting screw

Art. No. 125.00021



Due to the clamping ring connection, the hydraulic tubing is tightly fixed to the pump, respectively to the cylinder.

When tightening the connection screw (10 - 12 Nm), the clamping ring will squeeze itself onto the tubing.

Application:

- Tubing outer diameter 4 mm

Clamping ring

Art. No. 125.00022



Due to the clamping ring connection, the hydraulic tubing is tightly fixed to the pump, respectively to the cylinder. The clamping ring will squeeze itself onto the tubing when tightening the connection screw

Application:

- Tubing outer diameter 4 mm

Connection kit pump 4

Art. No. 113.00104



The connection kit includes::

- 1x Connection screw
- 5x Clamping rings
- 1x Magnet

Tubing plug

Art. No. 142.00198



For the transportation of a prefilled tubing, a tubing plug is needed. With the tubing plug all the prefilled hydraulic oil stays in the tubing.

Application:

- Tubing 113.00002

HYDRAULIC ACCESSORIES

Tubing assembly (complete)
Art. No. on request

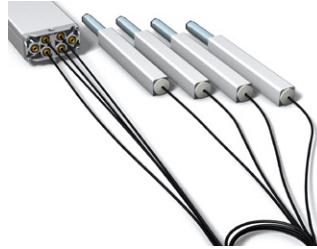

The tubing is connected to the cylinder and the pump. This is just possible with cylinders or linear units.
Advantage:
The system is ready to use.
Disadvantage:
It is not possible anymore to lay the tubing through holes or profiles.

Oil
250ml Art. No. 113.00009
1 liter Art. No. 113.00082



The oil is available in two sizes and is used to refill the hydraulic system. The hydraulic oil is called JAX FGH-AW ISO 22 and is suitable for use by food processing companies.

Service kit
Art. No. 113.00008-PP

[Purchase in the online shop!](#)



The service kit includes:

- 250 ml Oil (food grade hydraulic fluid)
- Injection 20ml with needle
- Tubing cutter
- Box wrench size 10/11
- Clamping rings and connecting screws
- Magnets

Tubing filled

1m	Art. No. 113.00161
2m	Art. No. 113.00162
3m	Art. No. 113.00163
4m	Art. No. 113.00164
5m	Art. No. 113.00165
6m	Art. No. 113.00166
7m	Art. No. 113.00137
8m	Art. No. 113.00168
10m	Art. No. 113.00160



Hose completely filled with oil (food-grade hydraulic fluid). Hose is welded on both sides.

Packed separately:

- Clamping rings and connection screws

HYDRAULIC ACCESSORIES

Y-connection

Art. No. 113.00015

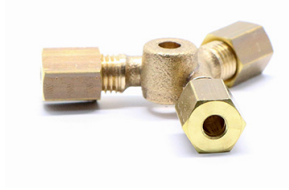

To connect two pressure elements with one cylinder the Y-connection is needed. The lifting speed will be doubled but the lifting load will be halved.

Please get in touch with our technicians to help you get the most suitable system.

L-connection

Art. No. 113.00017



With the L-piece, two tubings can be connected with each other. This serves for the tubing extension or tubing repair.

For bending radius <math><25\text{ mm}</math>.

Straight connection

Art. No. 113.00038



It is possible to connect two tubings with the straight connection. The straight connection is used for tubing extension or for tubing repair.

Tubing coupling click cpl.

Art. No. 113.00048



The tubing coupling click is used to disconnect the tubing without losing oil. Coupling and decoupling is possible up to a maximum pressure of 30 bars.

EXCESS FLOW CUT-OFF VALVE

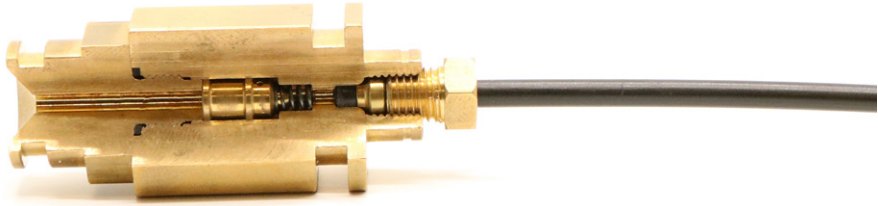

All Ergoswiss Cylinders, linear units and table legs are available with excess flow cut-off valve. Please contact our technicians for more information.

For more safety with heavy loads it is possible to use the excess flow cut-off valve. In the cylinder head, right before the tubing outlet, there is an excess flow cut-off valve which switches at too high flow rate. This prevents an uncontrolled descent or tilting of the table. The cylinder doesn't bounce for loads <50 kg. Then the table lowers slowly. The excess flow cut-off valve is integrated in the cylinder, no additional assembling is needed.

Technical specifications

Cut-off volume flow

- 300 ml/min

This is the retracting speed of 20mm/s if a cylinder with a diameter of 18mm is used.

The highest possible volume flow during operation is

- 140 ml/min = lifting speed 9 mm/s

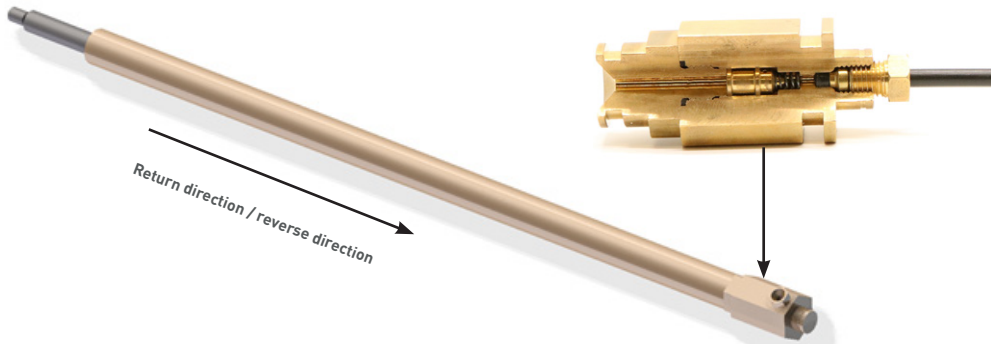

If a hydraulic hose is unintentionally torn off when the hydraulic system is extended, the oil can flow out of the cylinder unrestrained. The system sinks slowly and asynchronously and the following dangers may arise:

- Person is pinched by the system
- The object tilts, shifting the center of gravity
- A load falls off the object

Especially at high system loads, these hazards can result in serious injury to people and damage to the environment.

By a clean laying of the hoses the danger of a mechanical damage and a torn off can be clearly minimized!

Application:

306.20012	Linear unit LA 1820 V with hose
306.20013	Linear unit LA 1830 V with hose
306.10013	Linear unit LH 1830 V with hose
306.00553	Table leg TA 1830 V with hose
306.00554	Table leg TA 1840 V with hose
306.00463	Table leg TQ 1830 V with hose
309.50173	Cylinder CI 1830 V with hose
309.50174	Cylinder CI 1840 V with hose
309.50293	Cylinder CH 1830 V with hose
309.50294	Cylinder CH 1840 V with hose

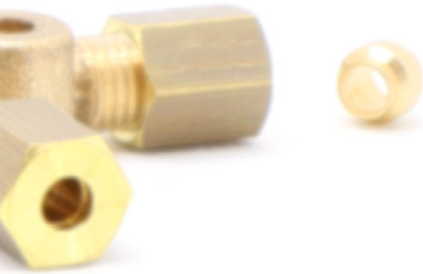

ERGOSWISS
table lift systems