

Schlauchanschluss  
Tubing connection

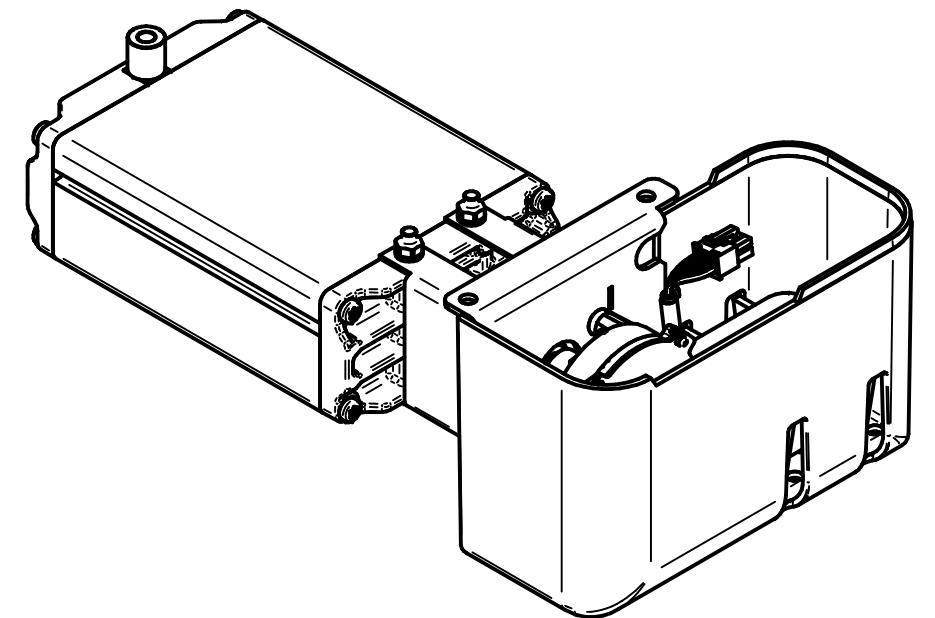

beigelegt / enclosed:

- Steuerung Compact / Control box Compact
- Motorkabel Compact / Motor cable Compact
- Handtaster Typ Memory / Hand switch Type Memory
- Länderspezifisches Netzkabel / Country specific power cable

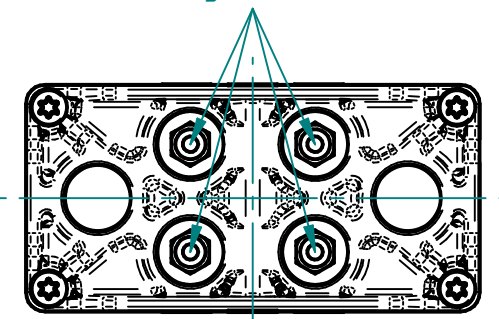
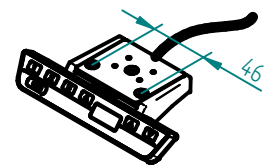
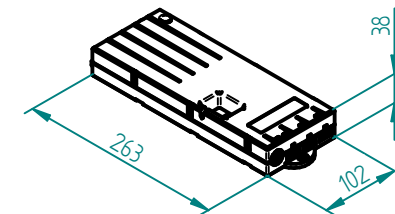

Pumpe / Pump	A	B	C	mit Antrieb EU with Motor unit EU	mit Antrieb CH with Motor unit CH	mit Antrieb US with Motor unit US
PB 4418 H	465.5	518.5	616.5	322.30153	332.30153	362.30152
PB 4430 H	707.5	760.5	858.5	322.30155	332.30155	362.30155
PB 4440 H	908.5	961.5	1059.5	322.30157	332.30157	362.30157

Index	Datum / Date	Name	Änderungsmittlung / notification of change		
	DATUM / DATE	NAME	GEWICHT / WEIGHT	BEZEICHNUNG / ASSEMBLY NAME	
GEZEICHNET / DRAWN	31.05.2024	thsp	---	Pumpe PB 44xx H mit Antrieb	
GEPRÜFT / CHECKED	31.05.2024	tiho	MABSTAB / SCALE 1:5	Pump PB 44xx H with Motor unit	
		ZEICHNUNGSNUMMER / DRAWING NUMBER	ARTIKELNUMMER / ASSEMBLY NUMBER	INDEX	FORMAT
		u-3X2.314	3X2.3XXXX	00	A3