

Schlauchanschluss
Tubing connection

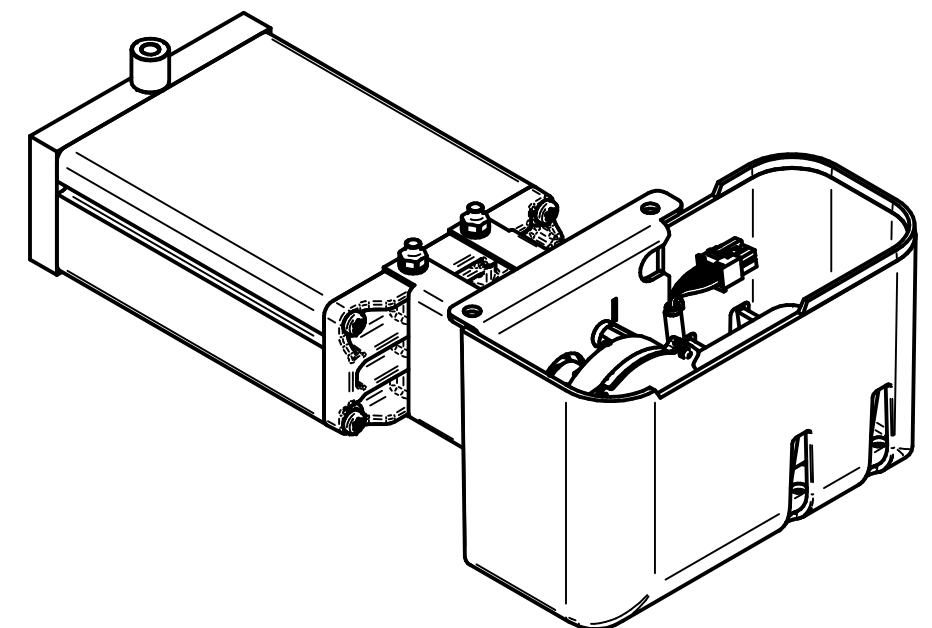

beigelegt / enclosed:

- Steuerung Compact / Control box Compact
- Motorkabel Compact / Motor cable Compact
- Handtaster Typ Memory / Hand switch Type Memory
- Länderspezifisches Netzkabel / Country specific power cable

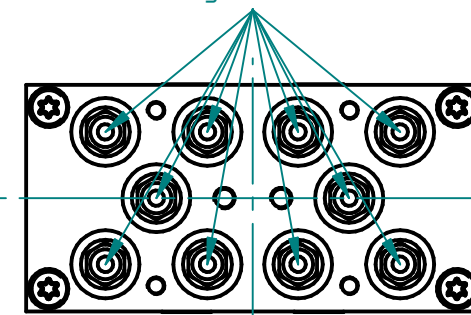
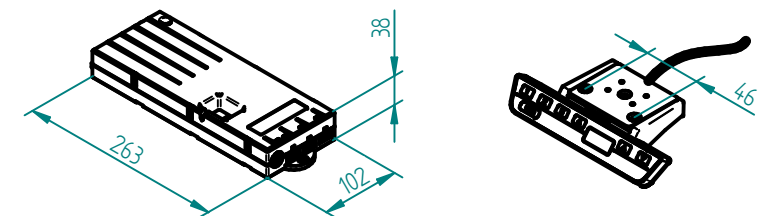

Pumpe / Pump	A	B	C	mit Antrieb EU with Motor unit EU	mit Antrieb CH with Motor unit CH	mit Antrieb US with Motor unit US
PB 0815 H	283.5	336.5	434.5	322.30281	332.30281	362.30281
PB 0820 H	343.5	396.5	494.5	322.30282	332.30282	362.30282
PB 0830 H	465.5	518.5	616.5	322.30213	332.30213	362.30213
PB 0840 H	585.5	638.5	736.5	322.30284	332.30284	362.30284
PB 0850 H	707.5	760.5	858.5	322.30285	332.30285	362.30285
PB 0860 H	827.5	880.5	978.5	322.30286	332.30286	362.30286
PB 0866 H	908.5	961.5	1059.5	322.30288	332.30288	362.30288
PB 0870 H	954.5	1007.5	1105.5	322.30287	332.30287	362.30287

Index	Datum / Date	Name	Änderungsmittteilung / notification of change		
	DATUM / DATE	NAME	GEWICHT / WEIGHT	BEZEICHNUNG / ASSEMBLY NAME	
GEZEICHNET / DRAWN	31.05.2024	thsp	sep. Stückliste mit gleicher Nr. sep. list of parts with same no.	---	Pumpe PB 08xx H mit Antrieb
GEPRÜFT / CHECKED	31.05.2024	tiho	MABSTAB / SCALE	1:5	Pump PB 08xx H with Motor unit
		ZEICHNUNGSNUMMER / DRAWING NUMBER	ARTIKELNUMMER / ASSEMBLY NUMBER	INDEX	FORMAT
		u-3X2.310	3X2.3XXXX	00	A3