

Handkurbel an Pumpe befestigt Hand crank mounted onto Pump

Handkurbel Typ H (113.00105) nicht im Lieferumfang enthalten!
Hand crank Type H (113.00105) is not included in scope of delivery!

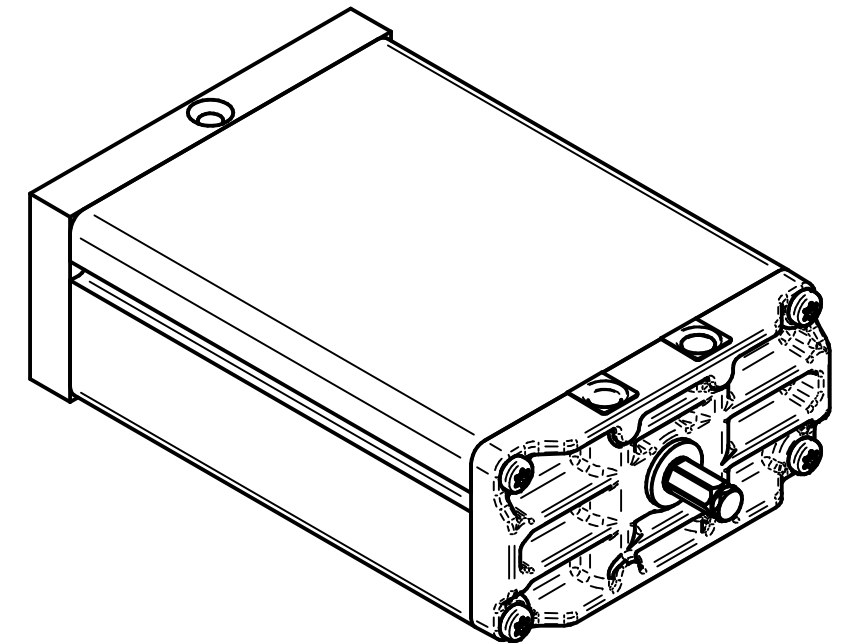
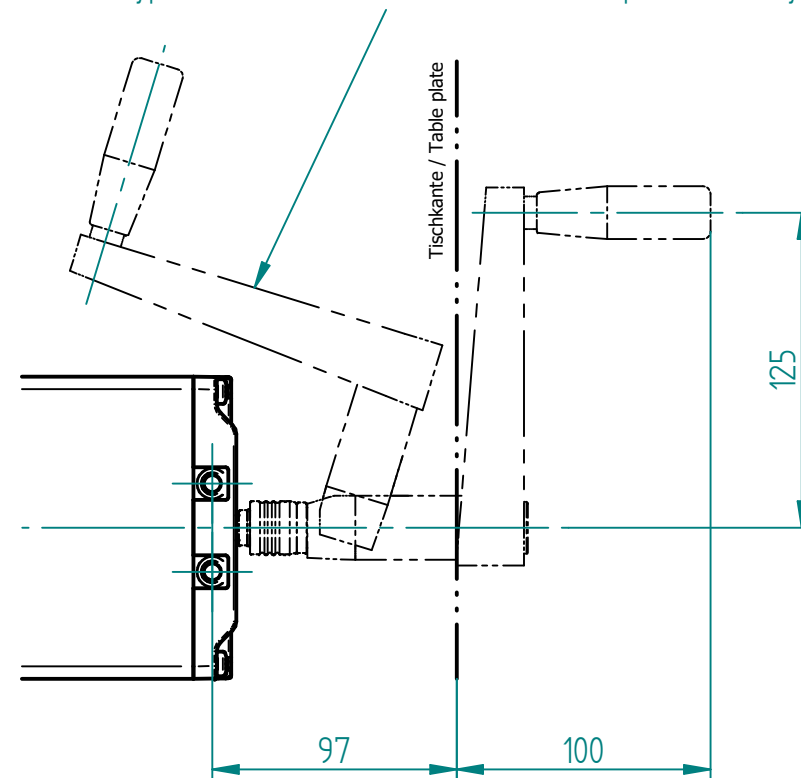

Pumpe / Pump	A	B	Artikelnr. / Article no.
PB 9815 H	283.5	298.5	102.30271
PB 9820 H	343.5	358.5	102.30272
PB 9830 H	465.5	480.5	102.30212
PB 9840 H	585.5	600.5	102.30274
PB 9850 H	707.5	722.5	102.30275
PB 9860 H	827.5	842.5	102.30276
PB 9866 H	908.5	923.5	102.30278
PB 9870 H	954.5	969.5	102.30277

Index	Datum / Date	Name	Änderungsmittellung / notification of change	
	DATUM / DATE	NAME	GEWICHT / WEIGHT	BEZEICHNUNG / ASSEMBLY NAME
GEZEICHNET / DRAWN	31.05.2024	thsp	---	Pumpe PB 98xx H
GEPRÜFT / CHECKED	31.05.2024	tiho	MABSTAB / SCALE 1:2	Pump PB 98xx H
ERGO SWISS table lift systems		ZEICHNUNGSNUMMER / DRAWING NUMBER	ARTIKELNUMMER / ASSEMBLY NUMBER	INDEX
		u-102.309	102.3xxxx	00
				FORMAT
				A3