

Operating instruction – Spindle lifting system SQ 13xx with SCT iSMPS 24V and Exchangeable battery



It is essential to read this operating instruction thoroughly before commissioning the system. The manual must be kept in close proximity to the system for future reference.



- ① Spindle lifting column of Type SQ
- ② Control box SCT iSMPS 24V
- ③ Exchangeable battery 24V
- ④ Hand switch Memory

- Example of a frame with two lifting columns:
- ⑤ Cross bar
 - ⑥ Adjustable foot

Errors and technical changes reserved.

Ergoswiss AG does not assume any liability for operating errors or using the products outside of the intended purpose use.

At the time of delivery Ergoswiss AG will replace or repair defect products within accordance with the warranty provisions. In addition, Ergoswiss assumes no other liability.

For your questions and special custom demand Ergoswiss AG will be at your disposal.

Ergoswiss AG
Nöllenstrasse 15
CH-9443 Widnau
Tel.: +41 (0) 71 727 06 70
Fax: +41 (0) 71 727 06 79

info@ergoswiss.com
www.ergoswiss.com

This operating instruction applies to:

Lifting system SQ 13xx with control box SCT iSMPS 24V and exchangeable battery

Example.: Lifting system SQ.3 4340 EU/CH 12 Battery (Item number: 907.42537)

	Description	Standard variations
SQ.3	Lifting element type	SQ.3
4340	Number of lifting elements	1, 2, 3, 4
4340	Spindle pitch in mm	3 mm
4340	Stroke length in cm	30 cm, 40 cm
EU	Power cable	EU/CH, US
12	11 = Hand switch Up-Down ; 12 = Memory	12
Battery	With exchangeable battery 10A	Battery

Frame SQ 13xx with control box SCT iSMPS 24V and exchangeable battery

Example.: Frame SQ.3 4340 995 EU/CH 12 Battery (Item number: 907.52583)

	Description	Standard variations
SQ.3	Lifting element type	SQ.3
4340	Number of lifting elements	4
4340	Spindle pitch in mm	3 mm
4340	Stroke length in cm	30 cm, 40 cm
995	Distance between lifting elements	Fixed-length cross bar
EU	Power cable	EU/CH, US
12	11 = Hand switch Up-Down ; 12 = Memory	12
Battery	With exchangeable battery 10A	Battery

Other versions

	Description
M12	With M12 thread connection
s01-s99	Special version: different position of threads, color, etc.

Notes over the operating instruction:

Lifting systems from Ergoswiss AG are intended for installation in an overall system (e.g. assembly table) and classified under the category of incomplete machines in accordance with the Machinery Directive 2006/42/EC.

This operating instruction contain information on the commissioning, handling and safety of the lifting system and are aimed at the further- user and manufacturer of the entire system. The further-user of this lifting system is obliged to create an operating manual with all usage information and hazard warnings for the entire system.

The declaration of incorporation is only valid for the Ergoswiss lifting system and not for the overall system created by the further-user.

Table of content

1	Safety requirements	4
1.1	Explanations of the symbols and notes	4
2	System description	5
2.1	General	5
2.2	Intended purpose use	5
2.2.1	General safety instructions	6
2.3	Target group and prior knowledge	6
2.4	Handling the Lithium-Ion Battery Pack	7
2.5	Performance characteristics	8
2.5.1	Lifting column SQ 13xx	8
2.5.2	Control box SCT2 iSMPS and SCT4 iSMPS	9
2.5.3	Hand switch Up/Down and Memory	9
2.5.4	Exchangeable battery package	10
2.5.5	System data	11
3	Mounting instructions	12
3.1	Mounting instructions Lifting column	12
3.2	Mounting instructions Battery set	13
3.3	Mounting instructions Control box	15
3.4	Mounting instructions Hand switch	17
3.4.1	Hand switch Memory	17
3.4.2	Hand switch Up-Down	17
4	Initial operation	18
4.1	Plug detection	18
4.2	Duty cycle monitoring	18
5	Operation with Hand switch Type Memory	19
5.1	Drive Up / Down	19
5.2	Saving and approaching a memory position	19
5.3	Limit the stroke length (Container-Stop/Shelf-Stop)	20
5.3.1	Limit upper end position - Shelf-Stop «S 04»	20
5.3.2	Limit lower end position – Container-Stop «S 05»	20
5.4	Setting the shown height on the display «S 06»	21
5.5	Changing the displayed unit of measurement (cm/inch) «S 07»	21
5.6	Deactivating / activating the tilt sensor «S 08»	22
5.7	Locking the movement (child protection)	23
5.8	Reference drive – Referencing the end positions	24
5.9	Restore to factory settings – Factory reset «S 00»	25
6	Operation with Hand switch Type Up-Down	26
6.1	Up / Down	26
6.2	Reference drive – Referencing the end positions	26
7	Safety strip – Squeezing protection	27
7.1	Commissioning	27
8	Maintenance and disposal	28
8.1	Maintenance and cleaning	28
8.2	Repairs and spare parts	28
8.3	Disassembly and disposal	28
8.4	Electrical and Electronic Equipment Act	28
9	Error codes and trouble shooting	29
9.1	Error codes on the display	29
9.2	Trouble shooting	30
10	Declaration of Incorporation	31

1 Safety requirements

The safety instructions must be paid attention to! If the system is operated improperly or not in accordance with the intended use, there may be a risk to persons and property!

Before installing and operating the lifting system, this operating instruction must be read and understood. The manual must be kept in the close proximity to the system for future reference.

1.1 Explanations of the symbols and notes

The following explanations of symbols and notes must be observed. These are classified according to ISO 3864-2 (ANSI Z535.4).

DANGER



Indicates an imminent danger.
Failure to follow the information will result in death or severe physical injury (disability).

WARNING



Indicates a potentially dangerous situation.
Failure to follow the information will result in death or severe physical injury (disability).

ATTENTION



Indicates a potentially dangerous situation.
Failure to follow the information will result in damage to property and minor or medium physical injuries will result.



NOTE
Indicates general information, useful user tips and work recommendations, which have no impact on the health and safety of staff.

2 System description

2.1 General

The basic functionality of a spindle lifting system SQ by Ergoswiss AG is the lifting and lowering of work surfaces, machine parts, profile systems, etc.

An operative spindle lifting System SQ consists of a minimum of following components:

- Lifting column SQ
- Control box SCT iSMPS
- Hand switch Memory
- Country specific power cable

The lifting column SQ consists of a colorless anodized aluminium profile and a standpipe made of stainless steel, which is guided in a plastic guide. The inner profile is moved by an inline spindle drive. Up to 4 spindle lifting elements can be connected to one control box SCT4 iSMPS and be operated synchronously.

The high-performance control box SCT4 iSMPS 24V is equipped with four motor channels, which are adjusted synchronously by an encoder converter. Due to the optimised driving comfort, the end positions are gently approached as low-speed zones up to the standstill. An integrated tilt sensor reacts to the system tipping and can prevent potentially dangerous situations. Additional functions, such as the synchronisation of two control boxes or the connection of safety strips (squeezing protection) can be used.

The control box is powered by the Exchangeable battery 10A. The maximum possible number of lifting cycles depends on the status of the battery-lifespan and the system load. If the exchangeable battery 10A is discharged, it must be removed from the holder and charged in the charging station.

The state of charge is indicated by four LEDs;

(1st LED = 25 % | 2nd LED = 50 % | 3rd LED = 75 % | 4th LED = 100 %).

With the hand switch Memory the lifting system can be operated comfortably, the work surface will be adjusted steplessly in its height.

The current height of the work surface is shown continuously on the display (in cm or inches). In addition, up to three different memory positions can be saved and approached individually. Errors that occur are also shown on the display.

2.2 Intended purpose use

Scope of application	NOT scope of application
<ul style="list-style-type: none"> → Height adjustment of worktops → Height adjustment of machine parts → Height adjustment of profile systems → ... the list is not exhaustive 	<ul style="list-style-type: none"> → Clamping tool → Press (or counterhold for press) → Passenger transport → Security component → ... the list is not exhaustive

2.2.1 General safety instructions

ATTENTION



The safety instructions must be paid attention to! If the system is operated improperly or not in accordance with the intended use, there may be a risk to persons and property!

The lifting system may be used if:

- it is located in closed rooms, in a dry and non-explosive environment.
- the ambient temperature is between +10 °C and +40 °C.
- the relative humidity range is between 30% and 70% (non-condensing).
- there are no strong electromagnetic fields nearby.
- This device can be used by children aged 8 and over and by persons with reduced physical, sensory or mental abilities or lack of experience and knowledge if they are supervised or have been instructed in the safe use of the device and the resulting dangers to understand.

The lifting system must not be:

- operated outside of the performance data (max. tensile, compressive, bending moment loads).
- subjected to impulse, impact and impact forces (e.g. setting down loads).
- operated with an incorrect mains voltage! Adhere to the type plate of the control box!
- designed for continuous operation (below the duty cycle ratio of 2/40).
- operated on unstable or sloping ground.
- operated with impermissible or non-designated components.
(e.g. different types of lifting elements; replacement of the control (control software))
- operated with damaged components.
- opened, reworked or rebuilt.
- operated if the power cable is not freely accessible. Disconnect the power cord in the event of a fault.
- Children must not play with the device. Cleaning and user maintenance shall not be made by children without supervision.

When installing and operating the lifting system, the intended use of the entire system must be adhered to. Commissioning is prohibited until the entire system complies with the provisions of the EC Directives 2006/42/EC (Machinery Directive). For this purpose, it is essential to perform a risk analysis, so that possible residual hazards can be reacted to (e.g. through constructive measures or through instructions in the operating instructions and/or through safety indication on the system). In the event of improper use, the liability of Ergoswiss AG and the general operating permit for the lifting system will expire.

2.3 Target group and prior knowledge

Before installing and operating the lifting system, this operating instruction must be read and understood. The manual must be kept in close proximity to the system for future reference.

This operating instruction addresses the following groups of people:

The **manufacturer of the overall system** who integrates this lifting system into an overall system and integrates these operating instructions into the operating instructions for the overall system.

The **commissioning personnel** who install the lifting system in a workplace, a machine, etc. and put it into operation. For commissioning basic mechanical and electrical knowledge are required.

2.4 Handling the Lithium-Ion Battery Pack

The exchangeable battery belongs to the class of portable batteries. As a rule, it works smoothly and maintenance-free. At the end of its lifetime, the power becomes smaller and the exchangeable battery should then be replaced.

Since the actual battery cells are surrounded by a plastic housing that also contains the charging electronics, no changes to them can be detected from the outside. The housing also provides additional protection against potentially leaked battery cells.

Disused exchangeable batteries, as well as old batteries made of power tools, garden tools and household appliances (e.g. vacuum cleaner robots) are taken back by municipal collection points.

ATTENTION



Do not open the housing to remove the battery cells before disposal!
Don't try to replace used battery cells with new ones!

If the housing of the exchangeable battery is damaged in such a way, that damage to the contained battery cells cannot be ruled out, it should be disposed of immediately. Preferably at the recycling centre and as a precaution in such a way, that it can be received by employees. Talk to the specialist staff and point out the damage.

Storage

Under no circumstances should you store the exchangeable battery in the refrigerator or water and not expose it to moisture. The storage temperature should be between 0 – 40 °C (32 – 104 °F), whereby lower temperatures are preferable. Due to self-discharge, recharging is required every 3 months.

Transport / Shipping

Lithium-ion batteries are classified as "dangerous goods" in international transport law. Thus, the regulations for the transport of dangerous goods are relevant for them.

The following rules apply to the modes of transport:

- Road: ADR
Accord européen relatif au transport international des marchandises Dangereuses par Route.
(European Agreement on the International Carriage of Dangerous Goods by Road)
- Rail: RID
Règlement concernant le transport international ferr viare de marchandises Dangereuses
(Regulation on the international carriage of dangerous goods by rail)
- Sea freight: IMDG Code
International Maritime Code for Dangerous Goods
- Air freight: IATA DGR
International Air Transport Association Dangerous Goods Regulations

2.5 Performance characteristics

2.5.1 Lifting column SQ 13xx

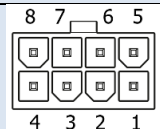
Lifting column SQ.3 13xx	
Cross-section	45 x 45 mm (1.77" x 1.77")
Standard stroke length	300, 400 mm (12", 16")
Installation length	Stroke length + 340 mm (13.39") Lower block position = stroke length + 337 mm (13.27")
Weight	SQ.3 1330 = 2.78 kg (6.1 lbs) SQ.3 1340 = 3.24 kg (7.1 lbs)
Max. allowed pressure load	1'500 N (337 lbf)
Max. allowed tensile load	1'500 N (337 lbf)
Power consumption	5 A per linear unit (at maximum load)
Voltage	24 V
Lifting speed	9 mm/s (0.35 "/s)
Noise level	< 60 dBA
Protection class (DIN EN 60529)	IP 20
Electrical connection	Molex MiniFit plug 8 Pin Cable length 2'000 m (79")
	 <ul style="list-style-type: none"> 1 Motor + 5 Pulse 2 2 ES 6 SYN 3 5V Hall Sensor 7 GND Hall Sensor 4 Pulse 1 8 Motor -
End switch	No (reading Encoder)
Tested product life	5'000 cycles with 400 mm (16") stroke length 1'500 N (337 lbf) pressure load, duty cycle 2/18 ①

① Duty Cycle 2/18; operating max. 2 min, pause 18 min

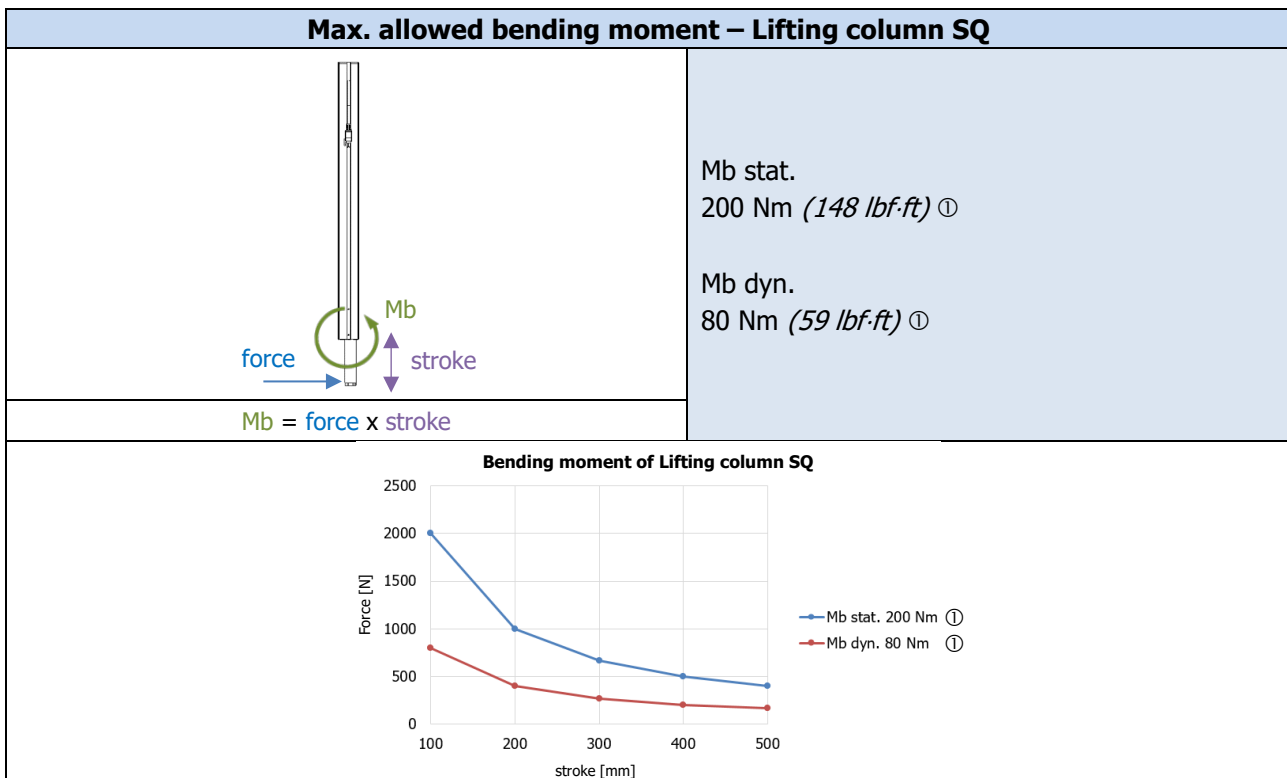

① stat. = during standstill; dyn. = during stroke movement

2.5.2 Control box SCT2 iSMPS and SCT4 iSMPS

Dimension (L x B x H)	309 x 120 x 55 mm (12.2" x 4.7" x 2.2")
Weight	SCT2: 1.12 kg (2.47 lbs) SCT4: 1.24 kg (2.73 lbs)
Supply voltage	EU: 207 – 254.4 V 50 Hz 4.5 A US: 103.5 – 127.2 V 60 Hz 7.4 A
Primary standby power	< 0.6 W
Power	580 VA ; 20 A @ 29 V DC
Protection class (DIN EN 60529)	IP 20
Performance Level (DIN EN 13849-1)	PL b

2.5.3 Hand switch Up/Down and Memory

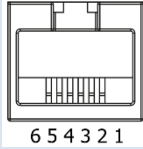
Electrical connection	RJ-12 plug 6 Pin Cable length 2 m (79")	
Protection class (DIN EN 60529)	IP 30	

1 UP 4 5V
2 RX 5 DOWN
3 GND 6 TX

6 5 4 3 2 1

2.5.4 Exchangeable battery package

Supply voltage	29 – 31 V DC
Supply current	250 mA; +/- 100 mA
Output power	250 W
Output voltage	16.8 – 29 V DC nominal 25.2 V
Output	10 A (for ED 1/9 ①) Short-term 20 A (only to absorb inrush currents) Overcurrent shutdown 14 – 20 A
Capacity	6'000 mAh
Temperature (operating)	0 – 40 °C (32 – 104 °F)
Temperature (storage)	0 – 55 °C (32 – 131 °F)
Temperature (transport)	0 – 55 °C (32 – 131 °F)
Relative humidity (operation, transport and storage)	< 85%; non-condensing
Load	During charging, the LEDs (power indicator) flash (1. LED = 25 % 2. LED = 50 % 3. LED = 75 % 4. LED = 100 %).
Reload	The battery is self-discharging, therefore recharging is required every 3 months. A full charge takes a maximum of 6h.
Overload	Charging is automatically terminated when: - Voltage of the internal battery block is greater than 29 V +/- 3 V, or - the voltage of a single cell is greater than 4.3 V. The battery is fully charged when all 4 LEDs are green
Charge low	The battery warns with an acoustic signal if the voltage of the internal battery block is less than 21 – 22 V. The battery should then be charged.
Discharge	The battery will automatically shut down if: - Voltage of internal battery blocks is less than 16.8 V +/-0.5 V, or - Voltage of individual cells is less than 2.5 V This state is called "battery discharged". Further discharge is prevented. This state is neither audible nor visually displayed and can only be terminated by charging.
Overcurrent shutdown	When the output current reaches values between 14 A and 20 A, the battery switches off immediately. When the output current is back in the nominal range, the battery can be used again. If necessary, this must be cooled and charged.
Short-circuit fuse	If a short circuit occurs at the output, the battery switches off immediately. When the short circuit has been eliminated, the battery can be used again. If necessary, the battery must be loaded

① Duty Cycle 1/9; operating max. 1 min, pause 9 min

2.5.5 System data

# Lifting elements	Max. System load [kg] (lbs)	Stroke length [mm] (in)	Lifting element Type	Control type 24 V	# of cycles per load- percentage at full Battery charge ②			Lifting speed	③ Duty Cycle [On/Off]
					100%	50%	0%		
1	125 (275)	300 (12")	① 1330	Battery (V1891)	100	200	400	6.5 - 8.5 mm/s (0.26 - 0.33 "/s) Load dependent	1/9 min
		400 (16")	① 1340	Battery (V1890)	80	160	320		
2	250 (550)	300 (12")	① 1330	Battery (V1891)	65	130	260		
		400 (16")	① 1340	Battery (V1890)	50	100	200		
3	300 (660)	300 (12")	① 1330	Battery (V1891)	40	80	160		
		400 (16")	① 1340	Battery (V1890)	30	60	120		
4	300 (660)	300 (12")	① 1330	Battery (V1891)	30	60	120		
		400 (16")	① 1340	Battery (V1890)	25	50	100		

① Lifting column SQ.3

② Duty cycle 2/18; operating max. 2 min, pause 18 min

NOTE



The lifting system can be subjected to uneven loads as long ...
 → the max. load on the single lifting element is not exceeded,
 → the max. bending torque of the lifting element is not exceeded,
 → the entire system is located on sufficient safe ground
 ... and the entire plant has been constructed in accordance with the provisions of the mechanical equilibrium. → Conducting a risk analysis

ATTENTION



High pulse / impact forces due to the discontinuation of loads are not allowed.
 (e.g. discontinuation of loads in feed with crane or forklift)

3 Mounting instructions

3.1 Mounting instructions Lifting column



NOTE

The lifting system must be mounted in such a way, that driving to the lower position with all lifting elements is possible at any time. Otherwise, no initial operating and reset of the system can be carried out.

Motor cable 2'000 mm (79")
With up to 5x Motor extension cable of 1'200 mm (47")
can be extended up to 8'000 mm (315")

Cross bar 40 x 40 mm (1.57 x 1.57")
Lengths in mm:
550, 750, 950, 1'150, 1'550

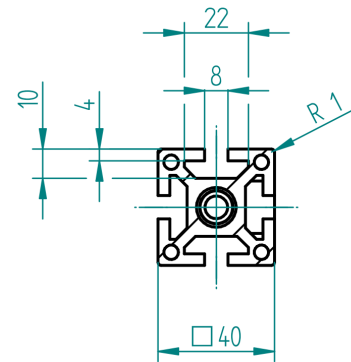

Mounting on T-slot (Cross bar)
External profile with T-slots on 2 sides
Cross section: 45 x 45 mm (1.77" x 1.77")

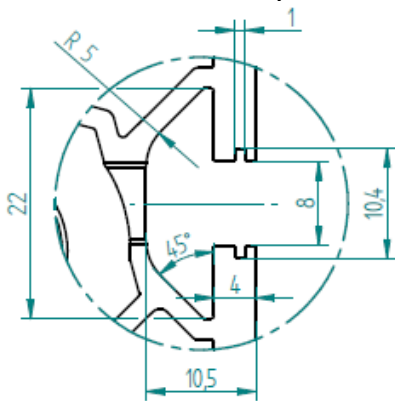

Thread M10 x 24



ATTENTION



The plug (with M10 thread) must be countered when attaching the accessories, otherwise the drive section will be strained and the system will be damaged!

3.2 Mounting instructions Battery set

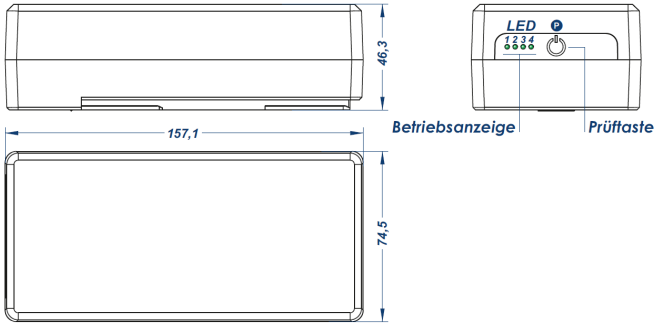
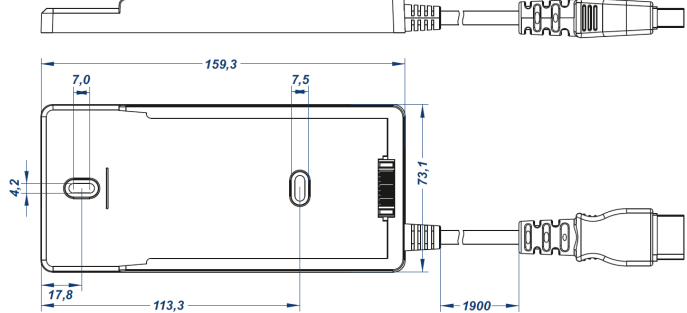
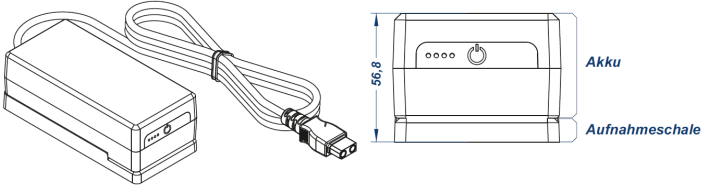
<p>Exchangeable battery 10 A</p> <p>The charge status of the exchangeable battery can be checked using the 4 LEDs of power/charging indicator indicator on the battery.</p> <p>To check the charging status, press the test button to the right of the LEDs.</p> <p>From right to left the LEDs show 25 %, 50 %, 75 % and 100 % of charge.</p>	 <p style="text-align: right;"><i>(drawing in mm)</i></p>
<p>Holder for exchangeable battery</p> <p>2x Slot hole → for screw size M4 (Ø4.2) (Ø0.16") → Torque max. 2 Nm (1.5 lbf-ft)</p> <p><i>(e.g.: Button head screw DIN 7981-C, Ø 3.5 mm (0.14"), head-Ø 6.9 mm (0.27"))</i></p> <p><i>Screws are not included in the scope of delivery.</i></p>	 <p style="text-align: right;"><i>(drawing in mm)</i></p>
<p>Exchangeable battery with Holder</p> <p>The exchangeable battery can be inserted into the holder.</p> <p>If the exchangeable battery is plugged into the holder, the set is in operating status.</p>	 <p style="text-align: right;"><i>(drawing in mm)</i></p>



NOTE

The mounting location provided for the holder should be easily accessible and chosen in such a way so that ...

- the exchangeable battery can be easily removed and
- the LED power indicator can be read without removal.

Docking station

The docking station can be connected to the electricity using the country specific charging cable.

A brand new battery must first be activated. This is done simply by plugging the battery into the docking station. After approx. 10 seconds, the power/charging indicator starts to light up green and the battery is being charged.

The charge status of the exchangeable battery can be checked using the 4 LEDs of power/charging indicator on the battery.

To check the charging status, press the test button to the right of the LEDs.

From right to left the LEDs show 25 %, 50 %, 75 % and 100 % of charge.



Only use the battery when it is fully (100%) charged.

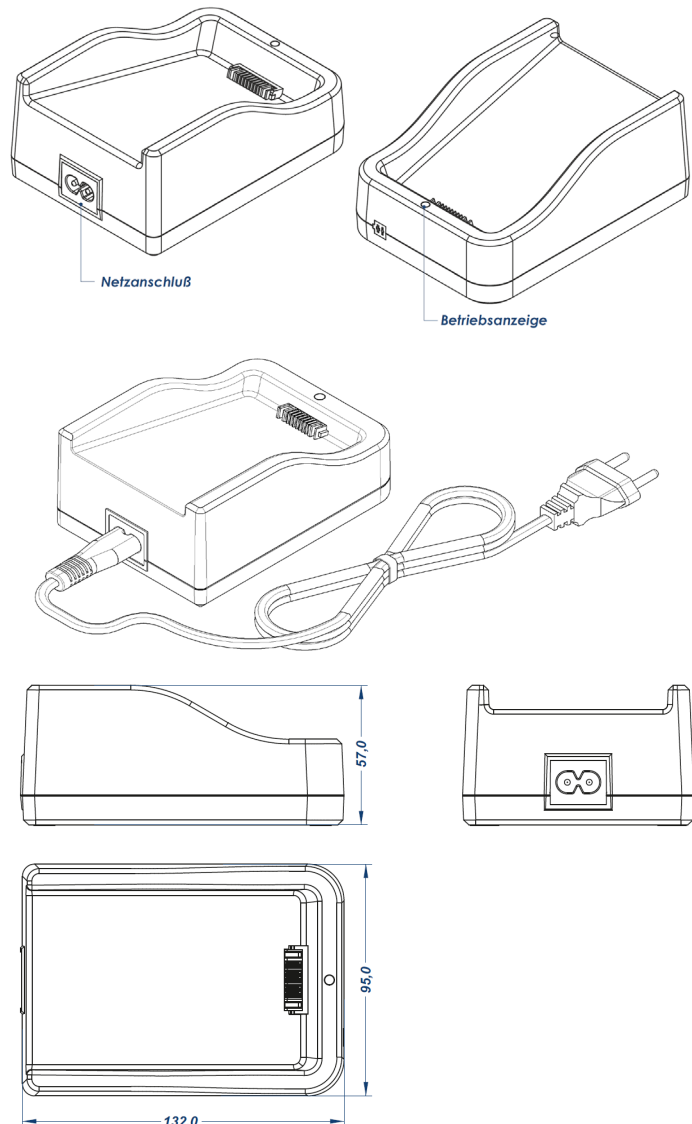

(drawing in mm)

ATTENTION



The exchangeable battery may only be charged with the included docking station!
This is the only way to ensure adequate security.

3.3 Mounting instructions Control box

ATTENTION



During mounting of the control box the power cable needs to be disconnected from the mains!



NOTE

The control box has an integrated tilting sensor as standard. To ensure the smooth normal operation, the control box must be fixed rigidly to the system before initial commissioning. (e.g. below the tabletop)

Mounting the control box at the bottom of a tabletop:

1. Place the control box to the desired location and mark the drill holes with a pen.



2. Pre-drill 3 holes (\varnothing 2.5 mm / 0.1").
Be careful not to drill through the table top!
3. Mount the control box with 3 screws.
(e.g.: Button head screw DIN 7981-C, \varnothing 3.9 mm (0.15"), head- \varnothing 7.5 mm (0.33")).



NOTE

When tightening the screws do not exceed a maximum torque of 2 Nm (1.5 lbf.ft)!



NOTE

The motor cable has a length of 1'800 mm (71"). If needed, up to 5 motor extension cables can be connected. They have a length of 1'200 mm (47") each.
→ 124.00137: Extension cable Motor SCT/Compact 1.2m (47")



NOTE

The cable of the hand switch has a length of 1'800 mm (71"). If needed it can be expanded with up to 3 extension cables. They have a length of 1'000 mm (39") each.
→ 124.00290: Extension cable Hand switch SCT 1m (39")

Control box SCT4 iSMPS 24V

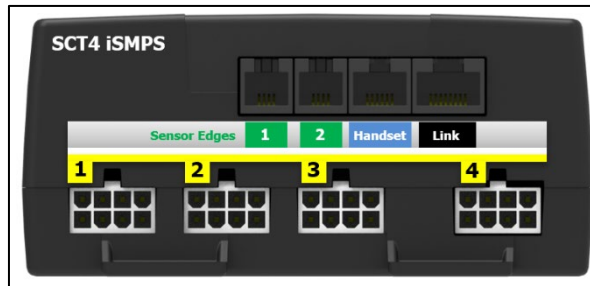

- | | | | |
|----------------|-----------------------------|----------|----------------|
| 1 | Connection for Safety strip | 1 | Motor socket 1 |
| 2 | Connection for Safety strip | 2 | Motor socket 2 |
| Handset | Connection for Hand switch | 3 | Motor socket 3 |
| Link | Connection for Sync cable | 4 | Motor socket 4 |

ATTENTION



Connecting homemade products to the control box is prohibited!
Only use supplied components.

4. Connect the motor cables to the control box in the correct order from **1** to **4**.
(Automatic plug detection on all sockets)
5. Connect the hand switch to the control box.
If necessary, optional components can now be connected (e.g. safety strips, sync cable).
6. Connect the Holder for exchangeable battery to the control box.

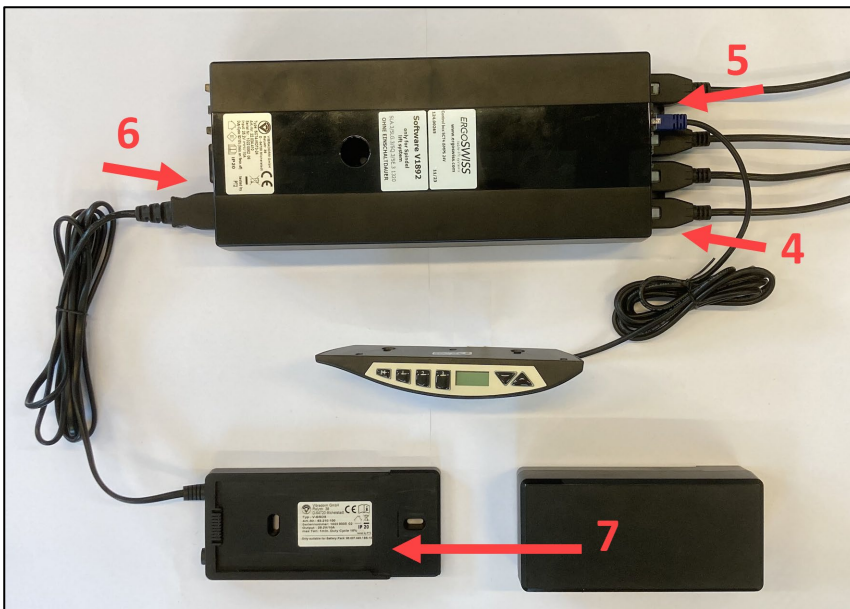

NOTE



Before connecting the Exchangeable battery onto the Holder the following must be verified:
 → Does the mains voltage correspond to the value on the name plate of the control box?
 → Are the plugs of the motor cable connected to the correct sockets (**1** to **4**)?
 → Is the entire lifting system assembled according to the assembly instructions?

7. Connect the Exchangeable battery onto the Holder.

3.4 Mounting instructions Hand switch

3.4.1 Hand switch Memory

1. Position the hand switch underneath the table plate. The control panel must overhang below the work surface!
2. Fasten the hand switch using the mounting screws. Be careful not to drill through the table top!

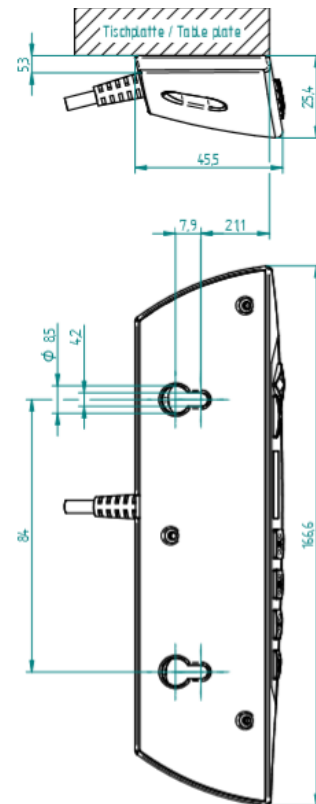

3.4.2 Hand switch Up-Down

1. Position the hand switch underneath the table plate. The control panel must overhang below the work surface!
2. Fasten the hand switch using the mounting screws. Be careful not to drill through the table top!

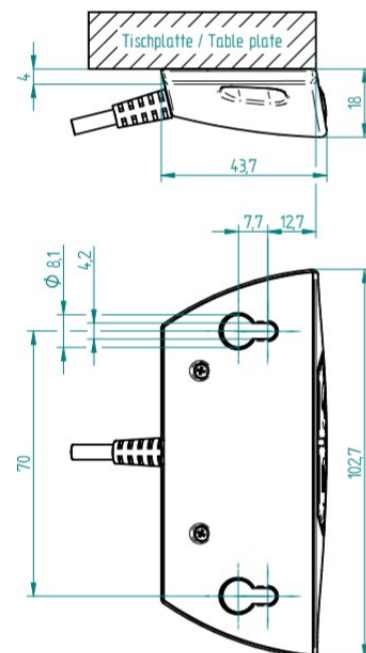

4 Initial operation

ATTENTION



Danger of squeezing during height adjustment!

ATTENTION



It must be possible to fully retract the lifting element to its lower block position at any time (also in the operating state).
If the lifting element cannot retract completely and hits a stop before it reached its lower block position, the zero position is set incorrectly. This leads to a collision when moving up to the upper block position.

ATTENTION







The system may only be fully loaded after the initial operation has been completed.
During the initial operation, the lifting system may be loaded with max. 50% of the system load.



NOTE

During the initial operation, the lifting system drives with half the speed.

1. Keep the buttons  and  pressed simultaneously to drive the lower block position.
The system moves downwards at half speed. Upward movement is disabled.
2. After reaching the block position, the system will drive out a few millimeters.
Afterwards the control box will emit 3 signal sounds.
3. let go of the buttons  and .

After reaching the block position, the lower and the upper position will be stored automatically.
The initial operation is completed.



NOTE

The lower position is 3 mm (0.12") higher than the block position. The upper position depends on the lifting element type, resp. of the control box software.

4.1 Plug detection

The control box can detect whether a lifting element is plugged into the relevant socket.

The control box only recognizes during the lifting movement whether a lifting element has been removed.
After plugging out or replacing a lifting element the system must be reset to synchronize all connected lifting elements.

4.2 Duty cycle monitoring

The duty cycle monitoring checks the ratio between the operation time and standstill time. To avoid overheating of the system a duty cycle of 2/40 (ON/OFF) should be maintained.

The maximum continuous operating time is 2 minutes. Afterwards a pause of at least 40 minutes needs to be observed before the system can be operated again.

5 Operation with Hand switch Type Memory



5.1 Drive Up / Down



This function is used for easy height adjustment of the system.

Press the button  or .

Keep the button pressed until the desired working height is reached.

5.2 Saving and approaching a memory position

With this function it is possible to memorise a certain position/height and approach it at a later time by pushing one button. With the 3 memory buttons up to 3 different positions can be stored and approached.

1. Drive to the desired position and press the button **M** 3 times.
2. Press one of the buttons    within 5 seconds.
After saving the control box will emit 1 signal sound.

The memory position is now stored under the pressed button.

To approach a stored memory position:

Keep one of the buttons    pressed until the desired working height is reached.

5.3 Limit the stroke length (Container-Stop/Shelf-Stop)

These two features can be used to limit the stroke length of the lifting system (e.g. if a container is under the table).













NOTE

The Shelf-Stop position limits the upper end position.
The Container-Stop position limits the lower end position.

5.3.1 Limit upper end position - Shelf-Stop «S 04»

To define a Shelf-Stop position, proceed as follows:

1. Keep the buttons   and  pressed simultaneously for 4 seconds.
→ The display shows «S 01», while the «S» is blinking.
2. Press the button  or  until «S 04» is selected.
3. Confirm the selection «S 04» with the button **M**.
→ The display stops blinking.
4. Press the button  or  to drive to the desired Shelf-Stop position.
5. Confirm with the button **M**.
→ The display shows «S 04».
6. Press the button   or  to leave the menu mode.













NOTE

To delete a set Shelf-stop position, a new one has to be done with the same procedure.

5.3.2 Limit lower end position – Container-Stop «S 05»

To define a Container-Stop position, proceed as follows:

1. Keep the buttons   and  pressed simultaneously for 4 seconds.
→ The display shows «S 01», while the «S» is blinking.
2. Press the button  or  until «S 05» is selected.
3. Confirm the selection «S 05» with the button **M**.
→ The display stops blinking.
4. Press the button  or  to drive to the desired Container-Stop position.
5. Confirm with the button **M**.
→ The display shows «S 05».
6. Press the button   or  to leave the menu mode.













NOTE

To delete a set Container-stop position, a new one has to be done with the same procedure.

5.4 Setting the shown height on the display «S 06»











The displayed height can be adjusted with this feature.

1. Keep the buttons   and  pressed simultaneously for 4 seconds.
→ The display shows «S 01», while the «S» is blinking.
2. Press the button  or  until «S 06» is selected.
3. Confirm the selection «S 06» with the button **M**.
→ The display shows the current height, while the «cm» is blinking.
4. Measure the height of the table.
5. Press the button  or  to adjust the measured height.
6. Confirm with the button **M**.
7. Press the button   or  to leave the menu mode.



5.5 Changing the displayed unit of measurement (cm/inch) «S 07»

This function can be used to change the height unit on the display from «cm» to «inch» or from «inch» to «cm».

1. Keep the buttons   and  pressed simultaneously for 4 seconds.
→ The display shows «S 01», while the «S» is blinking.
2. Press the button  or  until «S 07» is selected.
3. Confirm the selection «S 07» with the button **M**.
→ The display blinks «cm» or «inch».
4. Press the button  or  to select the desired measurement unit.
5. Confirm with the button **M**.
6. Press the button   or  to leave the menu mode.



The unit of measurement on the display has now been changed from centimeters (cm) to inches (inch) or from inches to centimeters (2.54 cm = 1 inch).

5.6 Deactivating / activating the tilt sensor «S 08»

The control box has an integrated tilt sensor, which is activated by default.

The 0° inclination of the control is initialized during initial operation or reset. If the inclination of the control exceeds 2.5° (e.g. inclined table), the control box stops the lifting movement. After triggering the tilt sensor, the system moves back by 10 mm (0.4"). If the inclination cannot be corrected (e.g. by driving in the opposite direction), a «Reference drive» must be performed.

ATTENTION



The tilt sensor is not a safety element!
There is still a risk of injury before the tilt sensor triggers.

NOTE

In addition to a collision, the tilt sensor can be triggered by various causes. Therefore, the following should be observed:



- Install the control box rigidly before initial operation or reset.
→ So that the inclination of 0° is properly initialized.
- After the system is moved, the tilt sensor should be reinitialized
→ Perform a «Reference drive» (see chapter 5.8).
- For mobile applications (e.g. table on castors), the tilt sensor should be deactivated.

This function can be used to deactivate the active tilt sensor or to reactivate the deactivated tilt sensor.

1. Keep the buttons   and  pressed simultaneously for 4 seconds.
→ The display shows «S 01», while the «S» is blinking.



2. Press the button  or  until «S 08» is selected.



3. Confirm the selection «S 0» with the button **M**.

The control gives an acoustic signal to confirm the change;



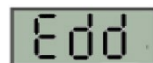

- If the tilt sensor has been deactivated, the control box will emit 3 signal sounds (short-short-long).
- When the tilt sensor has been activated, the control box will emit 1 signal sound.

4. If the tilt sensor is activated, the message «E dd» appears.
For the new initialization of the tilt sensor, a «Reference drive» must now be performed.



5.7 Locking the movement (child protection)

The locking function can be used to lock the control panel of the hand switch to prevent unintentional operation of the lifting system.

By activating the locking function, the lifting system can no longer move. Neither a movement with the buttons  or  nor moving to a memory position    is possible.

The lifting system is in the locked state as long as it is not deactivated.

ATTENTION



The locking function is not a safety element and does not avert danger!

Activate:

- Keep the buttons   and  pressed simultaneously for 4 seconds.
→ The control gives an acoustic signal to confirm the activation.



The lifting system is now locked and the display shows «E 65».

If any of the buttons on the hand switch is pressed, a signal tone sound and the system will not move.

Deactivate:

- Keep the buttons   and  pressed simultaneously for 4 seconds.
→ The control gives an acoustic signal to confirm the deactivation.

The system is not locked anymore and can be operated normally.

5.8 Reference drive – Referencing the end positions

ATTENTION



Before the reset, it must be ensured that:





- the lifting element can retract completely.
- the lifting system is loaded with a maximum of 50% of the maximum allowed system load.

If the lifting element cannot retract completely and hits a stop before it reached its lower block position, the zero position is set incorrectly. This leads to a collision when moving up to the upper block position.



NOTE

During restoring to the factory settings, the lifting system drives with half the speed.

1. If possible: Drive to lowest position with the button .
→ This saves time because the system only drives with half speed when doing a reset.
2. Keep the buttons  and  pressed simultaneously to drive the lower block position.
The system moves downwards at half speed. Upward movement is disabled.
3. After reaching the block position, the system will drive out a few millimeters.
Afterwards the control box will emit 3 signal sounds.
4. Let go of the buttons  and .

After reaching the block position, the lower and the upper position will be stored automatically.
The Reference drive is completed.

5.9 Restore to factory settings – Factory reset «S 00»

ATTENTION



Before restoring to factory settings, it must be ensured that:

- the lifting element can retract completely.
- the lifting system is loaded with a maximum of 50% of the maximum allowed system load.













If the lifting element cannot retract completely and hits a stop before it reached its lower block position, the zero position is set incorrectly. This leads to a collision when moving up to the upper block position.



NOTE

During restoring to the factory settings, the lifting system drives with half the speed.

When restoring the factory settings, the entire system is newly set up again. All settings such as Memory positions or End positions are lost.

1. If possible: Drive to lowest position with the button .
 - This saves time because the system only drives with half speed when doing a reset.
2. If needed, the system can now be rewired
 - a. Remove the cable from the mains.
 - b. Rewire the system: More lifting elements, synchronization cables or safety strips can now be connected.
 - c. Connect the power cable to the mains.
3. Keep the buttons   and  pressed simultaneously for 4 seconds.
 - The display shows «S 01», while the «S» is blinking. 
4. Press the button  or  until «S 00» is selected. 
5. Confirm the selection «S 00» with the button **M**.
 - The control gives an acoustic signal to confirm.
6. Press the button   or  to leave the menu mode.
 - The display shows «E dC». 
7. Do an initial operation according to chapter 4.

6 Operation with Hand switch Type Up-Down



With the Hand switch Type Up-Down, the lifting system can move up and down.

It is not possible to save a position, restrict the driving range, block the movement or reset the system to factory settings. This is only possible with the Hand switch Type Memory.

6.1 Up / Down

This function is used for easy height adjustment of the system.

- Press the button  or .
- Keep the button pressed until the desired working height is reached.

6.2 Reference drive – Referencing the end positions

ATTENTION



Before the reset, it must be ensured that:





- the lifting element can retract completely.
- the lifting system is loaded with a maximum of 50% of the maximum allowed system load.

If the lifting element cannot retract completely and hits a stop before it reached its lower block position, the zero position is set incorrectly. This leads to a collision when moving up to the upper block position.



NOTE

During restoring to the factory settings, the lifting system drives with half the speed.

1. If possible: Drive to lowest position with the button .
- This saves time because the system only drives with half speed when doing a reset.
2. Keep the buttons  and  pressed simultaneously to drive the lower block position.
The system moves downwards at half speed. Upward movement is disabled.
3. After reaching the block position, the system will drive out a few millimeters.
Afterwards the control box will emit 3 signal sounds.
4. Let go of the buttons  and .

After reaching the block position, the lower and the upper position will be stored automatically.
The Reference drive is completed.

7 Safety strip – Squeezing protection

ATTENTION



With lifting systems of Ergoswiss AG it is important to make sure that no objects or people are trapped during the lifting movement.
Danger of squeezing during lifting movement!

Attach the safety strip to an assumed squeeze zone. If the safety strip gets squeezed while the system moves, the motor will stop instantly and turn back for 5 motor rotations (ca. 15 mm (0.6")).

The safety strip (124.00157) consists of:

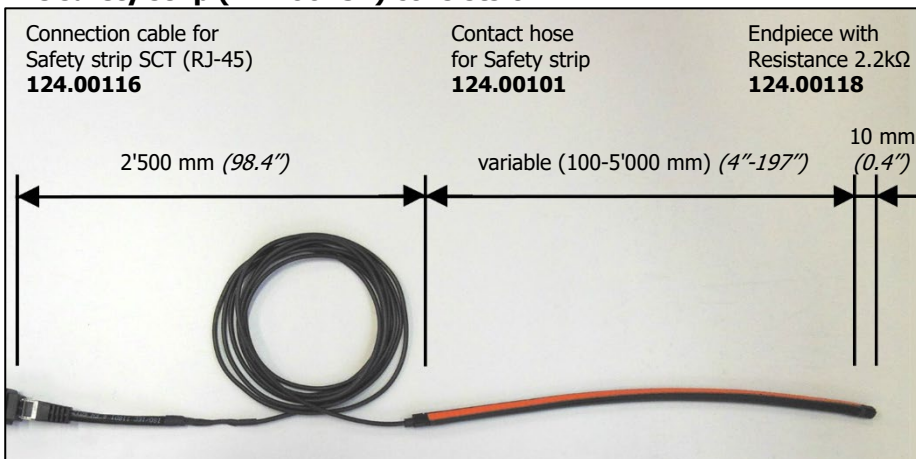

Functional properties of the contact tube

Contact angle	< 80 °
Switching pressure	< 25 N bei 23 °C
Switching travel	< 2 mm bei 23 °C
Minimum bending radius	B1 120 mm / B2 150 mm B3 20 mm / B4 20 mm
Max. tensile load	20 N

Electrical properties

Terminal resistance	2.2 kΩhm
Max. switching capacity	250 mW
Max. voltage	DC 24 V
Current min. / max.	1 mA / 10 mA

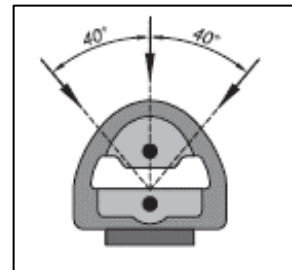
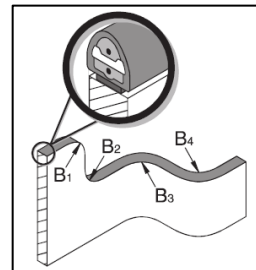

7.1 Commissioning

Gluing the contact tube in the squeeze zone

1. Clean and degrease the contact face.
2. Remove 10-15 cm (4" to 6") of protective film from the adhesive surface.
3. Place it on the contact face and press on well.
4. Repeat steps 2 and 3 until the contact tube is completely glued on.
5. Maximum adhesion is reached after 24 h.

Initial operation of control box with the safety strip

1. Wire the control box according to chapter 3.2.
2. The safety strip is connected in step 6.
3. Perform an initial operation according to chapter 4.

Adding the safety strip to existing control box

1. Reset the control box to factory setting (Factory reset «S 00») according to chapter 5.9.
2. The safety strip is connected in step 2.b.

8 Maintenance and disposal

8.1 Maintenance and cleaning

The lifting system is maintenance-free during normal operation resp. when complying with the intended use. Therefore a service is not required.

ATTENTION



The control box and the hand switch must only be cleaned with a dry or damp cloth. Before cleaning, the power cable has to be separated from the mains!

ATTENTION



No liquid is allowed to enter the plug connections!

8.2 Repairs and spare parts

Repairs must only be conducted by specialists. Only original replacement parts may be used. For all repair work the system must always be unloaded and voltage-free.

ATTENTION



In no case may the control box be opened! There is the risk of an electrical shock!

8.3 Disassembly and disposal

When decommissioning and disposing of the lifting system the electronic parts must be disposed of separately. The system consists of components that can be fully recycled and thus they are quite safe from an environmental protection perspective. The electronic parts comply with the RoHS directive.

8.4 Electrical and Electronic Equipment Act

The lifting system is not covered by the Electrical and Electronic Equipment Act (WEEE Directive 2012/19/EU).

Lifting systems from Ergoswiss AG are intended for installation in an overall system (e.g. assembly table) and classified under the category of incomplete machines in accordance with the Machinery Directive 2006/42/EC.

Therefore, these systems are not intended for private use.

9 Error codes and trouble shooting

9.1 Error codes on the display

Display	Description	Trouble shooting
E 60	Motor voltage supply below the permissible minimum	Check power supply. Connect power cable.
E 61	Total current has exceeded the programmed limit	System overloaded → Remove load from system System jammed → Remove clamped object Motor not connected correctly → Insert the motor cable correctly
E 62	User's input is invalid (Container-Stop or Shelf-Stop cannot be set)	Container-Stop must be defined under the Shelf-Stop, and Shelf-Stop must be defined above the Container-Stop (see chapter 5.3)
E 63	Inconsistent or damaged Motor control parameters recognized	Reprogram the control box → Contact customer support
E 64	Tilt sensor has been triggered (Inclination too high)	1) Undo the tilt. (e.g. by driving in the opposite direction) 2) Perform a «Reference drive» (see chapter 5.8)
E 65	Movement blocked (child lock)	See chapter 5.7
E 66	Safety strip was triggered	Remove jammed object
E 69	Safety strip is missing	Connect or replace the safety strip
E 6F	Lifting movement monitoring	System overloaded → Remove load from system System jammed → Remove clamped object Motor not connected correctly → Insert the motor cable correctly
E 71	Hall sensor → wrong motor direction	Contact customer support
E 73	Motor missing → no electricity	Check whether all motor cables are plugged in correctly
E 74	SYNC cable not recognized	Check if SYNC cable is plugged in and then perform a Factory reset «S 00» (see chapter 5.9)
E 78	Over-current on a motor	System overloaded → Remove load from system System jammed → Remove clamped object Motor not connected correctly → Insert the motor cable correctly
E 79	SYNC error (Connection error)	Check if SYNC cable is plugged in and then perform a Factory reset «S 00» (see chapter 5.9)
E 80	Battery Check in progress	Wait a few seconds and until the operation can be resumed.
E 7A	Position difference of the motors	Perform a «Reference drive» (see chapter 5.8)
E 7C	The control box has the slave role. Commands for motor are not possible.	Perform a Factory reset «S 00» (see chapter 5.9)
E C9	Lock due to Duty cycle monitoring. The maximum operating time has been reached.	To protect against overheating, operation is blocked in the following minutes. Wait a few minutes until the drive has cooled down, then the system is ready for operation again.
E CC	Motor turns faster than expected by the control box	Contact customer support

E D5	Motor position is not transmitted to control	Connect the motor cable and then perform a reset (see chapter 5.8)
E D7	Short circuit on one or more motor channels	Contact customer support
E D9	Motor current sensor or driver defective	Contact customer support
E DB	User has set limits incorrectly	Contact customer support
E DC	Control box must be restored to factory settings	Perform a Factory reset «S 00» (see chapter 5.9)
E DD	Control box must be reset	Perform a «Reference drive» (see chapter 5.8)

9.2 Trouble shooting

ATTENTION



The lifting system must not be opened, reworked or operated by impermissible components.

Error	Cause	Rectification
Drive does not work	Control box not connected	Connect power cable
	Motor not connected	Connect motor cable
	Motor defective	Contact customer support
	Control box defective	Contact customer support
	Hand switch defective	Replace the hand switch
	Bad connector contact	Plug in all plugs correctly
Drive only move to one direction	Control box defective	Contact customer support
	Hand switch defective	Replace the hand switch
Drive only moves downwards	System overload	Remove weight from the system

10 Declaration of Incorporation

EG-Declaration of Incorporation in the sense of the Machinery Regulation (EU) 2023/1230 annex V, Part B

We hereby declare that for the incomplete machine „spindle lifting system“, for ergonomically height adjustable workplaces or similar, with the variants

Lifting system SQ xxxx SCT
Frame SQ-x xxxx SCT

(Art. Nr. 907.4xxxx)
(Art. Nr. 907.5xxxx)

the following essential requirements of the Machinery Regulation (EU) 2023/1230 are applied and complied with:

1.1.2.; 1.1.3.; 1.1.5.; 1.1.6.; 1.2.; 1.3.2.; 1.3.4.; 1.3.9.; 1.5.1.; 1.5.3.; 1.5.4.; 1.5.7.; 1.5.8.; 1.5.9.

In particular the applied harmonized standards:

EN 1005	Safety of machinery: Physical performance
EN ISO 12100	Safety of machinery: 2011
EN 60335	Safety of electrical appliances for household use (110V version: UL 60950)
EN 61000	Electromagnetic compatibility: EMC (110V version: FCC Part 15 Class A)

specific technical documentation have been created in accordance with annex IV, part B, and will be sent to the national authorities by registered letter or electronically, if the request is justified, and this incomplete machine is in conformity with the relevant provisions of other EU Directives and Regulations:

89/391/EG	Safety and health of workers
2023/988/EU	Regulation on general product safety
2014/30/EU	Directive on electromagnetic compatibility
2014/35/EU	Low voltage directive

Furthermore, we declare that this incomplete machine may only be commissioned if it has been determined that the machine in which the incomplete machine is to be installed complies with the provisions of the Machinery Regulation (EU) 2023/1230 and our assembly and service operating instructions have been followed.

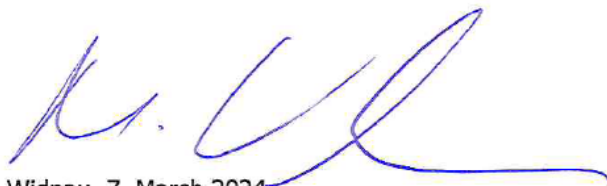

Widnau, 7. March 2024
Martin Keller
Managing Director / CEO

Document responsibility EU:

Ergoswiss Deutschland GmbH
Kronenstrasse 1
DE-72555 Metzingen